

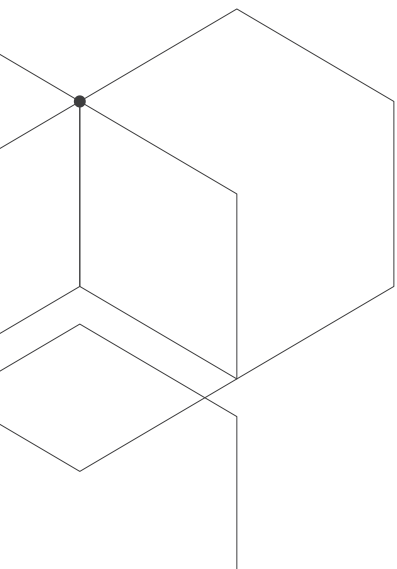

PROTECCIÓN SOLAR TOLDOS

SUN PROTECTION | AWNINGS

STRUGAL



STRUGAL
PROTECCIÓN
SOLAR
TOLDOS

STRUGAL
SUN
PROTECTION
AWNINGS

ÍNDICE

CONTENTS

STRUGAL
CORPORATIVO
STRUGAL CORPORATE

| | |
|---------------------------------------|----|
| GRUPO STRUGAL STRUGAL GROUP | 6 |
| BIM | 12 |
| STRUGAL GALLERY | 14 |

| | |
|---|----|
| PROTEGE TU BIENESTAR PROTECT YOUR WELLBEING | 18 |
|---|----|

| | |
|--|----|
| NUESTROS SISTEMAS DE PROTECCIÓN SOLAR OUR SUN PROTECTION SYSTEMS | 20 |
|--|----|

SISTEMAS TRADICIONALES TRADITIONAL SYSTEMS

| | |
|---|----|
| ST.1 Brazo acodado con tensión Tensioned angled arm | 26 |
|---|----|

| | |
|--------------------------|----|
| ST.1 Brazo Stor Stor Arm | 28 |
|--------------------------|----|

| | |
|---|----|
| ST.8 Brazo acodado con tensión + minicofre Tensioned angled arm + mini box | 30 |
|---|----|

SISTEMAS BRAZOS ARTICULADOS ARTICULATED ARM SYSTEMS

• Convencionales Conventional

| | |
|---------------------------------------|----|
| ST.2 Brazo articulado Articulated arm | 34 |
|---------------------------------------|----|

| | |
|---------------------------------------|----|
| ST.3 Brazo articulado Articulated arm | 38 |
|---------------------------------------|----|

• Cofres Boxes

| | |
|------------------|----|
| ST.4 Cofre Boxes | 42 |
|------------------|----|

| | |
|------------------|----|
| ST.5 Cofre Boxes | 46 |
|------------------|----|

| | |
|------------------|----|
| ST.6 Cofre Boxes | 50 |
|------------------|----|

• Monobloc Monobloc

| | |
|------------------------|----|
| ST.7 Monobloc Monobloc | 54 |
|------------------------|----|

SISTEMAS VERTICALES VERTICAL SYSTEMS

| | |
|-------------|----|
| ST.9 Screen | 58 |
|-------------|----|

| | |
|------------------|----|
| ST.10 Screen Zip | 62 |
|------------------|----|

| | |
|--------------|----|
| ST.11 Screen | 66 |
|--------------|----|

| | |
|---|----|
| ST.12 Cortaviento / Telón vertical Windbreak / Vertical curtain | 70 |
|---|----|

SISTEMAS DE JARDÍN Y TERRAZA GARDEN AND TERRACE SYSTEMS

| | |
|------------------|----|
| ST.15 Doble Dual | 74 |
|------------------|----|

SISTEMAS PLANOS FLAT SYSTEMS

| | |
|-------------------------------------|----|
| ST.20 Pérgola 80x40 Pergola 80 x 40 | 78 |
|-------------------------------------|----|

| | |
|------------------------------------|----|
| ST.21 Cortina lateral Side curtain | 84 |
|------------------------------------|----|

| | |
|--------------------------|----|
| ACABADOS FINISHES | 88 |
|--------------------------|----|

TOLDOS AWNINGS

SISTEMAS DE
PROTECCIÓN SOLAR
REMOTE MANAGEMENT
SUN PROTECTION

PÉRGOLAS BIOCLIMÁTICAS BIOCLIMATIC PÉRGOLAS

| | |
|-------------|-----|
| ST Libertia | 100 |
|-------------|-----|

DOMÓTICA Y MOTORIZACIÓN HOME AUTOMATION AND MOTORISATION

| | |
|---|-----|
| DOMÓTICA Y MOTORIZACIÓN HOME AUTOMATION AND MOTORISATION | 104 |
|---|-----|

| | |
|---|-----|
| LA DIFERENCIA ESTÁ EN LA CALIDAD THE DIFFERENCE IS IN THE QUALITY | 112 |
|---|-----|

| | |
|---|-----|
| SOSTENIBILIDAD SUSTAINABILITY | 114 |
|---|-----|

| | |
|---|-----|
| AL SERVICIO DEL INSTALADOR AT THE INSTALLER'S SERVICE | 116 |
|---|-----|

| | |
|---|-----|
| SOLVENCIA EN PRODUCCIÓN PRODUCTION EFFICIENCY | 118 |
|---|-----|

| | |
|---|-----|
| SISTEMA DE DISTRIBUCIÓN DISTRIBUTION SYSTEM | 120 |
|---|-----|

NUESTRO
COMPROMISO
OUR
COMMITMENT



STRUGAL

CORP



STRUGAL CORPORATE

GRUPO STRUGAL

STRUGAL GROUP

Desde hace 40 años en STRUGAL tenemos claro que queremos ser los mejores compañeros de viaje de nuestros clientes, ayudándoles a crecer, superando sus expectativas y haciendo de sus proyectos y retos los nuestros.

Por eso, queremos ir más allá de un buen producto y aportar a nuestros clientes soluciones a la medida de sus proyectos.

En STRUGAL diseñamos, fabricamos y distribuimos sistemas de cerramientos y fachadas para la arquitectura y la construcción que aúnan funcionalidad, creatividad y respeto por el medioambiente.

For 40 years at STRUGAL it has been clear to us that our aim is to be the best companions for our clients in their journey, helping them to grow, exceeding their expectations and making their projects and challenges ours.

This means we want to be more than a good product, and provide our clients with solutions tailored to their projects.

At STRUGAL we design, manufacture and distribute door and façade systems for architecture and construction that combine functionality, creativity and respect for the environment.

STRUGAL

STAC

NAZAN



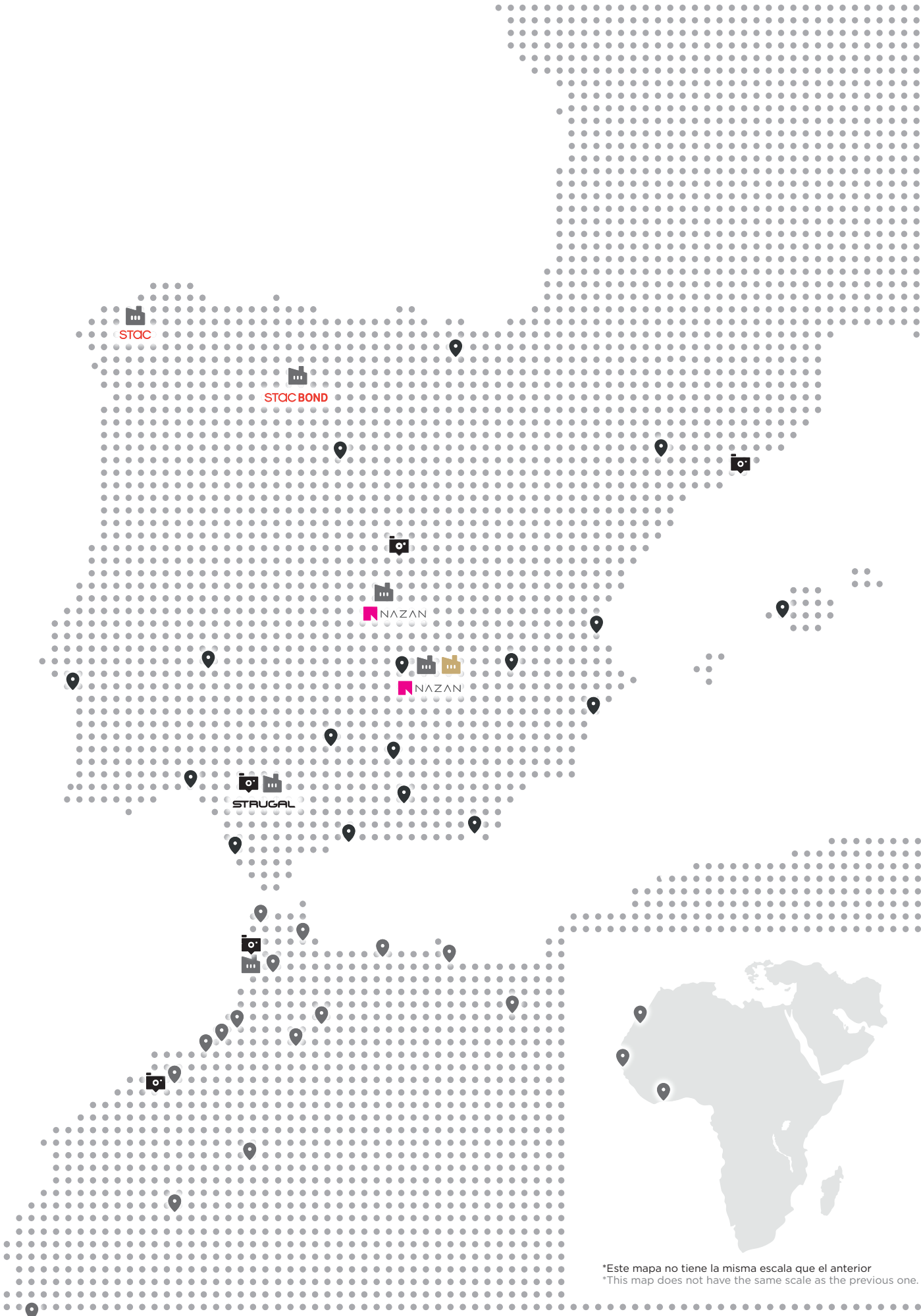

*Este mapa no tiene la misma escala que el anterior
 *This map does not have the same scale as the previous one.

- Centros de distribución**
 Distribution plants
- Distribuidores**
 Distributors
- Centros de producción**
 Production plants
- Centros de producción STRUGAL SOLAR**
 STRUGAL SOLAR Production plants
- STRUGAL GALLERY**

NOS UNE EL DISEÑO

UNITED **BY DESIGN**

Unir estética y funcionalidad es un reto que compartimos. En STRUGAL sabemos la importancia que tienen los detalles, las líneas, los conceptos que subyacen detrás de cada forma.

Hacer tangible un concepto nunca ha sido fácil. Por eso, contamos con un equipo de trabajo multidisciplinar que nos permite conjugar innovación, tecnología y creatividad en el diseño y desarrollo de cada una de nuestras soluciones y sistemas.

Detrás de cada uno de nuestros productos hay todo un proceso de investigación, un reto que resolver, una idea, una solución para que tus proyectos se materialicen en espacios habitables de alto valor estético.

Uniting aesthetics and functionality is a challenge that we share. At STRUGAL we know the importance of the details, the lines, the underlying concepts behind each shape. Making a concept tangible has never been easy.

To achieve this, we have a multidisciplinary work team that allows us to combine innovation, technology and creativity in the design and development of each of our solutions and systems.

Behind each of our products lies a complete research process, a challenge to solve, an idea, a solution so that your projects come to fruition in living spaces of high aesthetic value.



300.000 m² de instalaciones
m² of facilities

26.000 t de aluminio al año
t of aluminium per year

180.000 uds. de ventanas y puertas de aluminio al año
Aluminium doors and windows per year

130.000 uds. de ventanas de PVC al año
PVC windows per year

5 prensas de aluminio
Aluminium Presses

8 plantas de lacado
Lacquer plants

2 plantas de anodizado
Anodising Plants

UNA SOLUCIÓN **PARA CADA IDEA**

A SOLUTION **FOR EVERY IDEA**

Analizamos las necesidades de la arquitectura más contemporánea para lograr la excelencia. Trabajamos con la vista puesta en los máximos estándares de calidad y en la obtención de las más altas prestaciones para cada ventana, cada fachada y cada cerramiento.

Siempre a la vanguardia de nuestro sector, trabajamos una amplia gama de productos y acabados pensados para integrarse a la perfección en todo tipo de proyectos arquitectónicos.

We analyse the needs of the most contemporary architecture in pursuit of excellence. We work with an eye on the highest standards of quality and on obtaining the best performance for each window, each façade and each door.

Always at the forefront of our sector, we work with a wide range of products and finishes designed to perfectly integrate with all types of architectural projects.

ESTAMOS **A TU LADO**

WE ARE **WITH YOU**

La Red de Consultores Técnicos de STRUGAL, RED COTEC, compuesta por arquitectos e ingenieros de la edificación tiene como objetivo estar a tu lado en todo momento, asesorándote, resolviendo dudas y problemas y ayudándote a dar forma a tus proyectos. Este equipo se complementa con nuestra Oficina Técnica, especializada en ingeniería y arquitectura, pensada para darte un soporte técnico adaptado a tus necesidades y proyectos.

The STRUGAL Network of Technical Consultants (RED COTEC) consists of architects and building engineers ready to support you at any time, advising you, resolving doubts and problems, and helping you shape your projects. This team is complemented by our Technical Office, specialising in engineering and architecture, whose role is to give you technical support tailored to your needs and projects.

UNA OFICINA TÉCNICA **A TU SERVICIO**

A TECHNICAL OFFICE **AT YOUR SERVICE**

Te ayudamos a optimizar tiempo y recursos. Ponemos a tu disposición nuestra Oficina Técnica para proporcionarte asistencia en:

- Elaboración de la memoria de carpintería y cálculo de resistencias.
- Cálculo energético para la optimización del aislamiento térmico.
- Asesoramiento en presupuestación e instalaciones.
- Seguimiento en obra.
- Departamento de Calidad que analiza todas las variables de cada procedimiento para que el producto final sea óptimo.

We help you optimise time and resources. Our Technical Office is at your disposal to provide assistance in:

- Drafting of the blueprint and calculation of resistances.
- Energy calculation for optimisation of thermal insulation.
- Advice on budgeting and installation.
- On-site follow-up.
- Quality Department that analyses all the variables of each procedure so that the final product is optimal



1.500 profesionales a tu servicio
professionals at your service

23 países en los que tenemos presencia
countries in which we operate

40 años de experiencia
years of experience

STRUGAL

BIM: AÚN MÁS EFICIENTES

BIM: EVEN MORE EFFICIENT

En STRUGAL hemos digitalizado todo nuestro catálogo de sistemas, disponible desde cualquier aplicación BIM. Ahora, nuestros productos tienen réplicas digitales, convertidos en objetos inteligentes que contienen gran cantidad de información del sistema, reproduciendo virtualmente su comportamiento en la realidad. De esta forma, seas diseñador, arquitecto o ingeniero ahora puedes acceder e integrar toda esta información digital a tus proyectos de forma sencilla.

El BIM o Building Information Modeling está suponiendo una auténtica revolución en los procesos y forma de trabajar para los profesionales de la construcción. Basado en reproducción 3D de cada uno de los elementos constructivos, posibilita el diseño paramétrico de forma sencilla, rápida y completa.

At STRUGAL we have digitised our entire catalogue of systems, making it available from any BIM application. Our products now have digital replicas, converted into smart objects that contain a large amount of system information, a virtual reproduction of their actual behaviour. With this, you can now easily access and integrate all this digital information into your projects, whether you are a designer, architect or engineer.

BIM, or Building Information Modelling, is creating a true revolution in the way construction professionals work and in their processes. Based on 3D reproduction of each construction component, it enables parametric design in a simple, fast and complete way.





RED COTEC

La Red de Consultores Técnicos de STRUGAL tiene como objetivo estar a tu lado en todo momento, asesorándote, resolviendo dudas y problemas, y ayudándote a dar forma a tus proyectos.

The goal of the STRUGAL Network of Technical Consultants is to support you at all times, advising you, resolving doubts and problems, and helping you shape your projects.



DPTO. DE ESTUDIOS

Diseño de soluciones BIM a medida que se adaptan a cada una de las particularidades de tus proyectos.

STUDY DEPARTMENT: design of customised BIM solutions tailored to all the unique aspects of your projects.



OFICINA TÉCNICA

Nuestro equipo de ingeniería y arquitectura te ayudará a optimizar tiempo y recursos, dándote un soporte técnico adaptado a tus necesidades.

TECHNICAL OFFICE: our engineering and architecture team will help you optimise time and resources, giving you technical support tailored to your needs..



WEB ACTUALIZADA

Nuestro contenido conectado con la plataforma garantiza que la descarga siempre esté actualizada.

UPDATED WEBSITE: our platform connected content ensures that the download is always up to date.

ACCEDE A NUESTRA BIBLIOTECA STRUGAL

ACCESS OUR
STRUGAL LIBRARY



Ya puedes entrar en nuestra biblioteca desde cualquier lugar mediante este **código QR** o desde la siguiente url:

www.strugal.com/bim

You can now access our library from anywhere using this **QR code** or by following the url:

www.strugal.com/bim

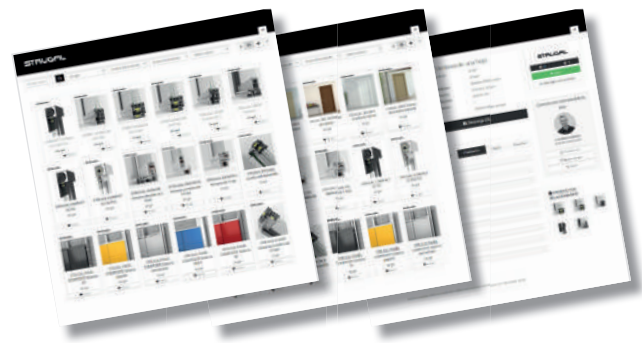

The image shows a modern gallery space with a rustic stone wall. A long, black, rectangular table is positioned in the foreground, extending towards the center. The floor is made of light-colored wood in a herringbone pattern. On the left, there is a dark door with a glass panel. The ceiling has track lighting. The text "STRUGAL GALLERY" is centered on the stone wall.

STRUGAL
GALLERY



ESPACIOS STRUGAL GALLERY

**ARQUITECTURA Y DISEÑO. FORMACIÓN.
SHOWROOM. EXPOSICIONES.**

Bienvenido al punto de encuentro de profesionales de la construcción y el diseño.

STRUGAL Gallery pone a tu disposición un espacio para asistir a jornadas técnicas y prácticas relacionadas con el sector del cerramiento. Conviértelo en tu nueva oficina celebrando reuniones y sesiones de trabajo.

Visita con tus clientes el showroom de productos **STRUGAL**, un espacio en el que el diseño, la cercanía y la arquitectura son los protagonistas.

SPACES STRUGAL GALLERY

**ARCHITECTURE AND DESIGN. TRAINING.
SHOWROOM. EXHIBITIONS.**

Welcome to the point for construction and design professionals to come together. STRUGAL Gallery offers you an installation to attend technical conferences and practices related to the door sector. Make it your new office in which you hold meetings and work sessions. Visit the STRUGAL product showroom with your clients, where design, proximity and architecture play the leading roles.



SEVILLA

Pol. Ind. La Red Sur
C/ La Red 9 N°11.
Alcalá de Guadaíra

MADRID

C. de Columela,
9, Bajo izquierda

BARCELONA

C/ Pau Claris
163 BJS. 1

CASABLANCA

89 Bd Omar Al Khayam,
Résidence Prestige
Salma, Beauséjour

LARACHE

Ctra. Nacional I, km.
92, Comune Rurale
Laouamra, Maroc

STRUGAL
GALLERY





AS DE PROTECCIÓN SOLAR

SUN PROTECTION SYSTEMS

COBÍJATE DEL SOL, PROTEGE TU BIENESTAR

SHELTER YOURSELF FROM THE SUN, **PROTECT YOUR WELLBEING**

Los Sistemas de Protección Solar de STRUGAL están específicamente diseñados para ofrecer multitud de ventajas, tanto a tu vivienda como a tu vida. Más **espacio**, más **protección** y mayor **ahorro energético**.

Gánale metros a tu casa, y disfruta con los tuyos de una mayor zona habitable en tu hogar gracias a nuestra gama de toldos.

Muebles, marcos de ventanas, tapicería ... Protege el interior de tu vivienda de los nocivos rayos UV del sol.

Y todo, mientras ahorras energía y disminuyes las emisiones de CO₂ a la atmósfera.

STRUGAL's Sun Protection Systems are specifically designed to offer a multitude of advantages, both for your home and for your life. More **space**, more **protection** and greater **energy savings**.

Add more space to your property, and enjoy a larger living area in your home with your loved ones thanks to our range of awnings.

Furniture, window frames, upholstery... Protect the inside of your home from the sun's harmful UV rays.

All while saving energy and reducing CO₂ emissions into the atmosphere.

NUEVOS ESPACIOS NEW SPACES

Ya sea aumentando el espacio útil de la vivienda o ampliando la funcionalidad de uno existente, las soluciones de toldos aportan no solo más metros a tu casa, sino a tu vida. Una forma sencilla de transformar un espacio y hacerlo más confortable y acogedor.

Whether it's increasing your usable living space or extending the functionality of an existing space, awning solutions not only add more space to your home, but to your life. They're a simple way to transform a space and make it more comfortable and welcoming.

CALIDAD DE VIDA QUALITY OF LIFE

Sácale más partido a tus espacio al aire libre como la terraza o el jardín. Aumenta tu bienestar y mejora tu calidad de vida.

Get more out of your outdoor space, such as your terrace or garden. Increase your wellbeing and improve your quality of life.





ECOLOGÍA Y ECONOMÍA

ECOLOGY AND ECONOMY

Nuestros Sistemas de Protección Solar suponen una manera efectiva de controlar el consumo de energía de tu hogar, controlando la luz y el calor que provienen del exterior.

Our Sun Protection Systems are an effective way to control your home's energy consumption by controlling the light and heat coming in from outside.



CONFORT

COMFORT

Un buen filtrado de la luz protege nuestro confort visual. Haz más satisfactorias las actividades cotidianas como leer, ver la televisión o trabajar con el ordenador bajo el toldo en tu terraza, o tras el sistema vertical en tu salón.

Good light filtering protects our visual comfort. Make everyday activities more satisfying, such as reading, watching TV or working on the computer under the awning on your terrace, or behind the vertical system in your living room.



DISEÑO

DESIGN

El diseño importa. Y por ello nuestros diseñadores industriales hallan el equilibrio perfecto entre funcionalidad, belleza, y prestaciones técnicas.

Design matters. And that's why our industrial designers find the perfect balance between functionality, beauty and technical performance.

NUESTROS **SISTEMAS** **DE PROTECCIÓN SOLAR**

OUR SUN PROTECTION SYSTEMS

TOLDOS

AWNINGS

■ SISTEMAS TRADICIONALES Traditional systems



ST.1 BRAZO ACODADO



ST.1 BRAZO STOR



ST.8 BRAZO ACODADO
+ MINICOFRE

■ SISTEMAS DE BRAZOS ARTICULADOS Articulated arm systems



ST.2 BRAZO ARTICULADO



ST.3 BRAZO ARTICULADO



ST.4 COFRE



ST.5 COFRE



ST.6 COFRE

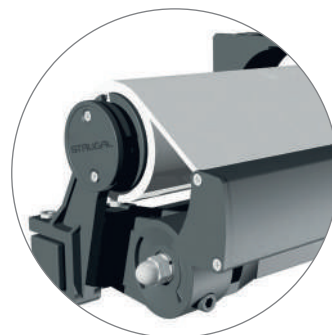

ST.7 MONOBLOC

PÉRGOLAS BIOCLIMÁTICAS

BIOCLIMATIC PERGOLAS

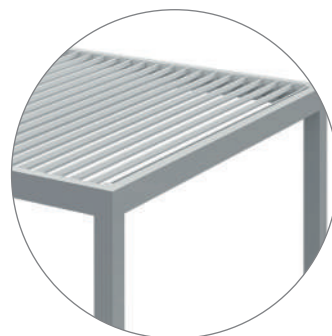

ST LIBERTIA

■ SISTEMAS VERTICALES Vertical systems

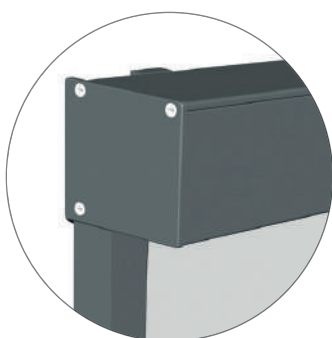

ST.9 SCREEN

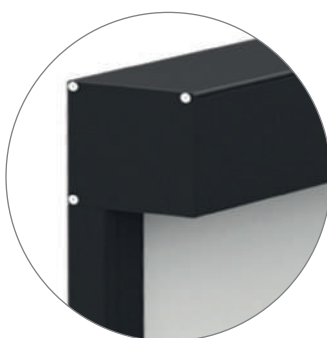

ST.10 SCREEN ZIP

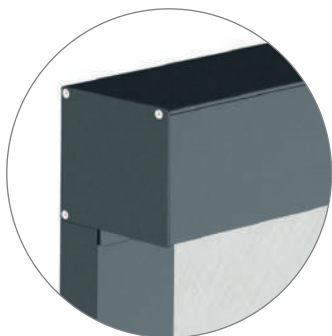

ST.11 SCREEN

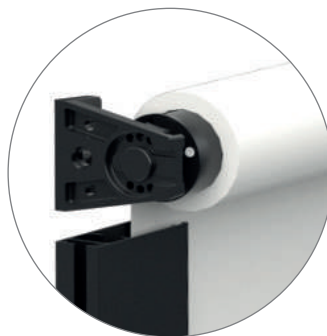

ST.12 CORTAVIENTO / TELÓN VERTICAL

■ SISTEMAS PLANOS Flat systems



ST.20 PÉRGOLA 80X40



ST.21 CORTINA

■ SISTEMAS DE JARDÍN Y TERRAZA Garden and terrace systems



ST.15 DOBLE PENDIENTE





DOS

AWNINGS



ST. 1

BRAZO ACODADO
CON TENSIÓN

TENSIONED ANGLED

BRAZO STOR

STOR ARM

Este modelo de toldo es autoportante con fijación directa, y se adapta tanto a fachada como a techo. La estructura, fabricada con perfiles de aluminio extrusionado y piezas de fundición, resiste a la intemperie y cumple la Norma UNE-EN 13561:2015 a este respecto.

This awning model is self-supporting with direct fixing, and adapts to both façade and roof. The structure, made of extruded aluminium profiles and cast iron parts, is weather-resistant and complies with UNE-EN 13561:2015 standard in this respect.

ST. 1 BRAZO ACODADO CON TENSIÓN

TENSIONED ANGLED ARM



Norma Standard
UNE-EN 13561:2015

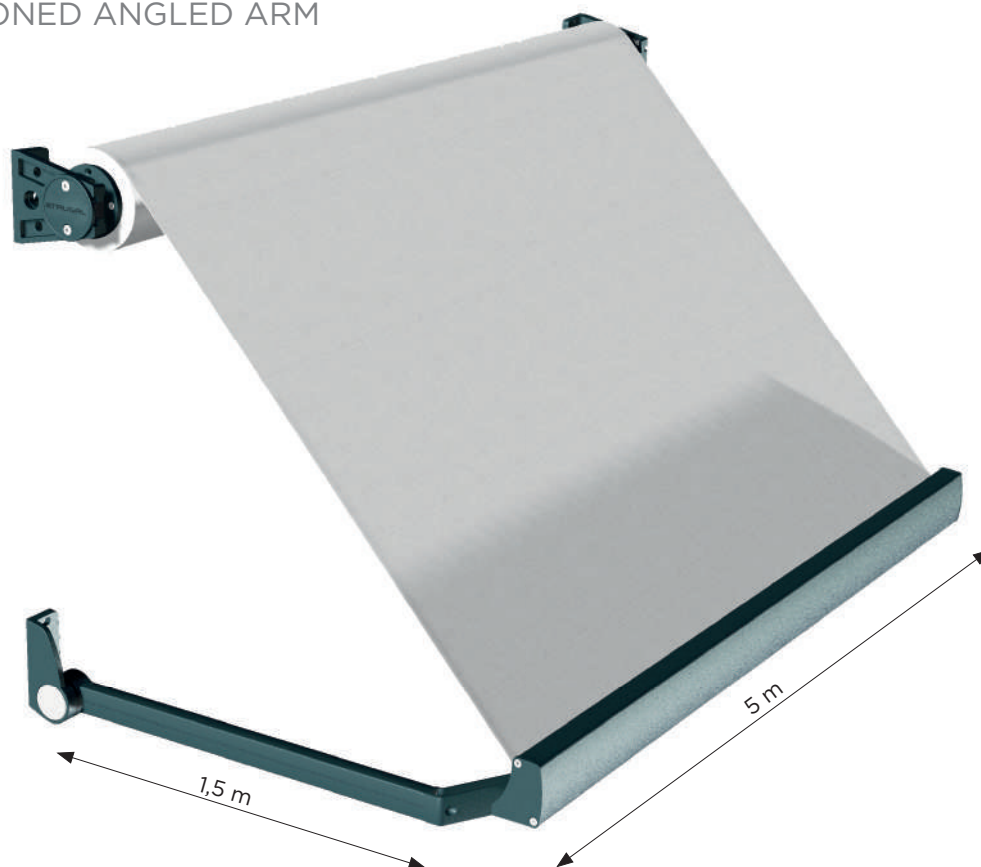

CARACTERÍSTICAS TÉCNICAS

Technical characteristics

CARACTERÍSTICAS

Features

- ▶ Sistema con abatimiento frontal de los brazos. System with front folding arms
- ▶ Producto STRUGAL siempre tensionado, con un sistema de tensores interiores que estira la lona y evita movimientos violentos en el toldo. A permanently tensioned STRUGAL product, with an internal tensioning system that stretches the fabric and avoids violent movements in the awning.

DIMENSIONES MÁXIMAS

Maximum dimensions

Salida/proyección Extension/projection: 0.80 m - 1.50 m

Línea/ancho Line/width: 5 m

Inclinación Angle: 0 to 160°

INSTALACIONES HABITUALES

Standard installations



Ventanas
Windows



Balcones
Balconies

ACCIONAMIENTOS

Actuators



Manual
Manual



Motorizado
Motorised

SUJECIÓN

Fastening

■ DIFERENTES POSIBILIDADES

Different options

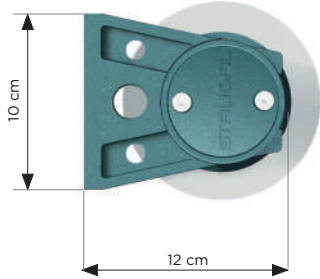

A techo
Mounted to ceiling



Frontal
Front



Entreparedes
Between walls

INCLINACIÓN

Angle

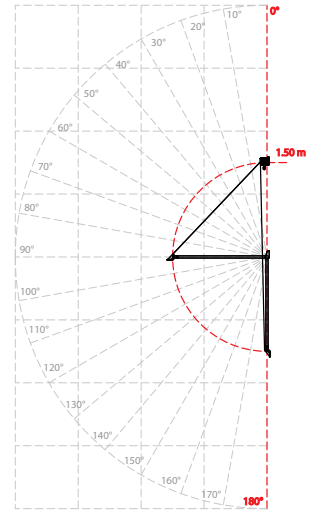

Medidas en mm. Measurements in mm.

SOPORTE

Surface

■ VISTA FRONTAL

Front view

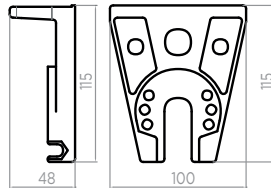

■ VISTA SUPERIOR

Top view

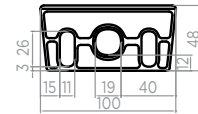

RESISTENCIA AL VIENTO

Wind resistance

| SALIDA DE BRAZO EN METROS Arm extension in metres | LÍNEA EN METROS Line in metres | | | | | |
|--|-----------------------------------|---|-----|---|-----|---|
| | 2,5 | 3 | 3,5 | 4 | 4,5 | 5 |
| 1,5 | CLASE 1 CLASS 1 | | | | | |

ST. 1 BRAZO STOR

STOR ARM



Norma Standard
UNE-EN 13561:2015



CARACTERÍSTICAS TÉCNICAS

Technical characteristics

CARACTERÍSTICAS

Features

► En este sistema los elementos estructurales son recogidos ya que la barra de carga se eleva con la tela y los brazos quedan plegados sobre esta. In this system, the structural elements are retracted as the load bar raises with the fabric and the arms are folded over the fabric.

► Posibilidad de colocarlo a techo y poder sujetar los brazos, que van incorporados, a la barra de carga o barandilla. Option to attach it to the ceiling and to attach the arms, which are incorporated, to the load bar or handrail.

DIMENSIONES

MÁXIMAS

Maximum dimensions

Salida/proyección (medida de brazo) Extension/projection (arm measurement): 0.50 m

Línea/ancho Line/width: 5 m

Inclinación Angle: 0 to 160°

INSTALACIONES HABITUALES

Standard installations



Balcones
Balconies



Terrazas
Terraces

ACCIONAMIENTOS

Actuators



Manual
Manual



Motorizado
Motorised

SUJECIÓN

Fastening

■ DIFERENTES POSIBILIDADES

Different options

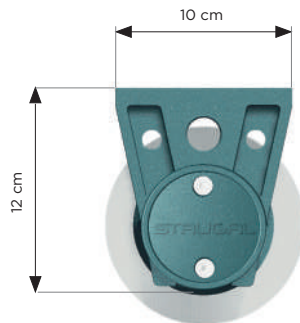

A techo
Mounted to
ceiling



Frontal
Front



Entreparedes
Between walls

SOPORTE

Surface

Medidas en mm. Measurements in mm.



■ VISTA FRONTAL

Front view

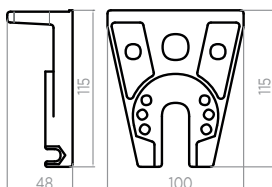

■ VISTA SUPERIOR

Top view

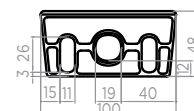

ST. 8

BRAZO ACODADO CON TENSIÓN + MINICOFRE

TENSIONED ANGLED ARM + MINI BOX

Variante del ST.1 Brazo Acodado con Tensión, al que aporta un perfil cofre que protege la lona cuando está recogida sobre el tubo de enrollamiento.

Variant of the ST.1 Tensioned Angled Arm, adding a box profile that protects the fabric when it is retracted on the winding tube.





ST. 8 BRAZO ACODADO CON TENSION + MINICOFRE

TENSIONED ANGLED ARM + MINI BOX



Norma Standard
UNE-EN 13561:2015



CARACTERÍSTICAS TÉCNICAS

Technical characteristics

CARACTERÍSTICAS

Features

- ▶ Sistema con abatimiento frontal de los brazos. System with front folding arms.
- ▶ Producto STRUGAL siempre tensionado, con un sistema de tensores interiores que estira la lona y evita movimientos violentos en el toldo. Permanently tensioned STRUGAL product, with an internal tensioning system that stretches the fabric and avoids violent movements in the awning.
- ▶ Perfil cofre para una protección integral de la lona cuando está recogida. Box profile for all-round protection of the fabric when retracted.

DIMENSIONES MÁXIMAS

Maximum dimensions

Salida/proyección Extension/projection: 0.80 m - 1.50 m
Línea/ancho Line/width: 5 m
Inclinación Angle: 0 to 180°

INSTALACIONES HABITUALES

Standard installations



Ventanas
Windows



Balcones
Balconies

ACCIONAMIENTOS

Actuators



Manual
Manual



Motorizado
Motorised

SUJECIÓN

Fastening

■ TECHO

Roof

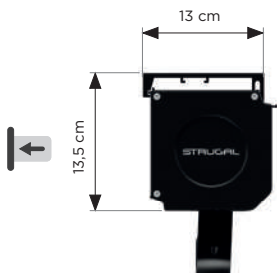

■ FRONTAL

Front

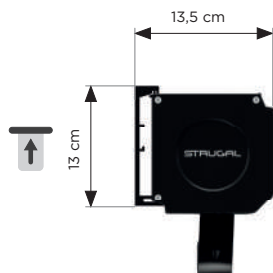

INCLINACIÓN

Angle

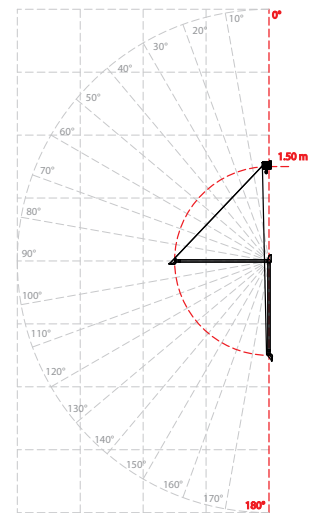

SOPORTE

Surface

Medidas en mm. Measurements in mm.

■ VISTA FRONTAL

Front view

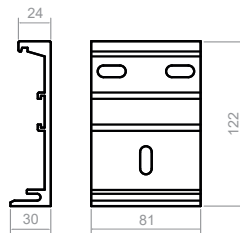

■ VISTA SUPERIOR

Top view

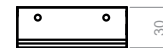

RESISTENCIA AL VIENTO

Wind resistance

| SALIDA DE BRAZO EN METROS Arm extension in metres | LÍNEA EN METROS Line in metres | | | | | |
|--|-----------------------------------|---|-----|---|-----|---|
| | 2,5 | 3 | 3,5 | 4 | 4,5 | 5 |
| 1,5 | CLASE 1 CLASS 1 | | | | | |





ST. 2

BRAZO ARTICULADO

ARTICULATED ARM

Toldo de pequeñas dimensiones.
Diseño sobrio y elegante, apto para
cualquier tipo de construcción.

Small awning. Sober and
elegant design, suitable for any
type of construction.

ST. 2 BRAZO ARTICULADO

ARTICULATED ARM



Norma Standard
UNE-EN 13561:2015

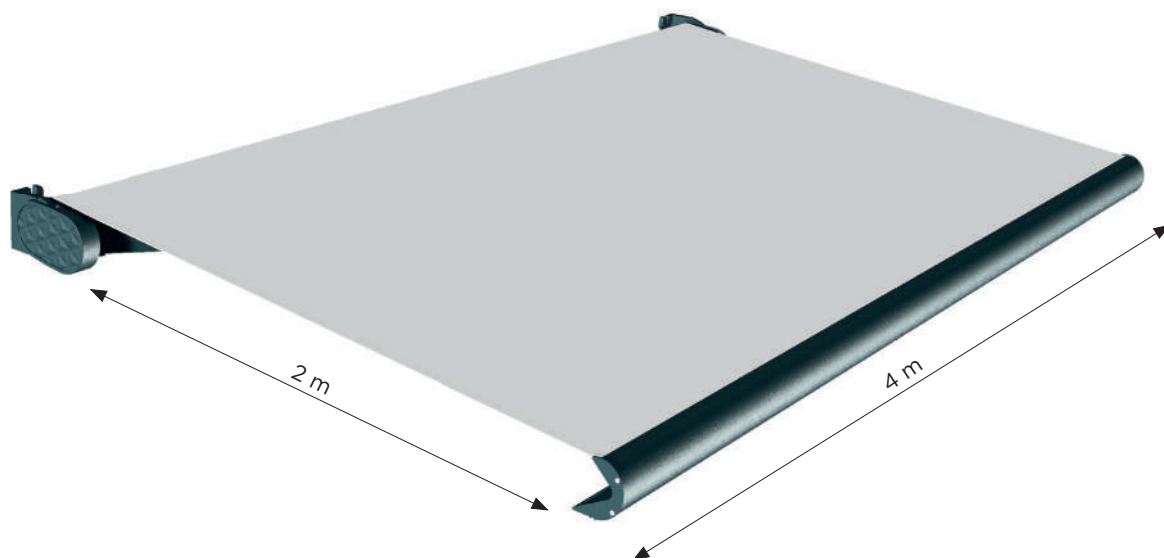

CARACTERÍSTICAS TÉCNICAS

Technical characteristics

CARACTERÍSTICAS

Features

- ▶ Toldo de pequeñas dimensiones con estética sobria y elegante.
Small awning with a sober and elegant aesthetic.
- ▶ Gran resistencia gracias a su sistema de perfiles de aluminio extruido y piezas de fundición.
High resistance thanks to its system of extruded aluminium profiles and cast iron parts.
- ▶ Resistencia al viento según la Norma UNE-EN13561:2015.
Wind resistance according to Standard UNE-EN13561:2015.

DIMENSIONES MÁXIMAS

Maximum dimensions

Salida/proyección Extension/projection: 2 m
Línea/ancho Line/width: 4 m
Inclinación Angle: 0 to 60°

INSTALACIONES HABITUALES

Standard installations



Ventanas
Windows



Balcones
Balconies



Terrazas
Terraces

ACCIONAMIENTOS

Actuators



Manual
Manual



Motorizado
Motorised

SUJECIÓN

Fastening

TECHO

Roof

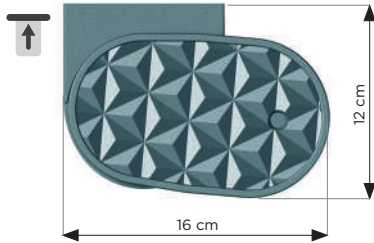

FRONTAL

Front

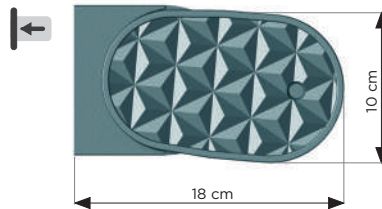

INCLINACIÓN

Angle

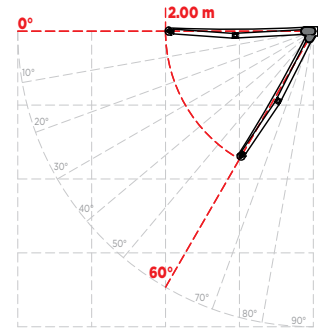

SOPORTE

Surface

Medidas en mm. Measurements in mm.

VISTA FRONTAL

Front view

VISTA SUPERIOR

Top view

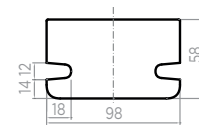
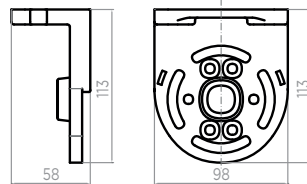

RESISTENCIA AL VIENTO

Wind resistance

| SALIDA DE BRAZO EN METROS Arm extension in metres | LÍNEA EN METROS Line in metres | | | |
|--|-----------------------------------|---|-----|---|
| | 2,5 | 3 | 3,5 | 4 |
| 1,5 | CLASE 1 CLASS 1 | | | |
| 2 | | | | |

LÍNEA MÍNIMA

Minimum line

| SALIDA Exit (m) | 1.25 | 1.50 | 1.75 | 2.00 |
|-------------------------------|------|------|------|------|
| LÍNEA MÍNIMA Minimum line (m) | 1.85 | 2.10 | 2.35 | 2.60 |



ST. 3

BRAZO ARTICULADO

ARTICULATED ARM

Sistema de placas de anclaje fácil con diseño exclusivo. La estructura se envía totalmente montada.

Easy anchorage plate system with exclusive design. The structure is shipped fully assembled.

ST. 3 BRAZO ARTICULADO

ARTICULATED ARM



Norma Standard
UNE-EN 13561:2015

Autoportante
FIJACIÓN DIRECTA.
Self-supporting
DIRECT FIXING.

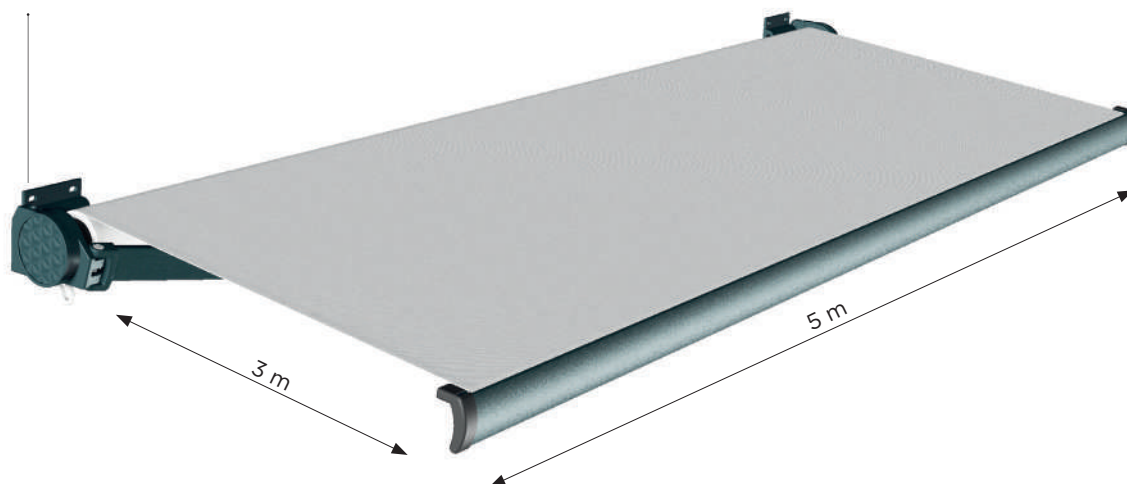

CARACTERÍSTICAS TÉCNICAS

Technical characteristics

CARACTERÍSTICAS

Features

- ▶ Toldo autoportante con fijación directa. Self-supporting awning with direct fixing.
- ▶ Sistema de brazos articulados, con soportes de enrollado capaces de encajar en cualquier pequeña superficie dado su reducido diseño. Articulated arm system, with roll-up brackets capable of fitting on any small surface due to its small design.
- ▶ Estructura resistente de perfiles de aluminio y piezas de fundición. Sturdy structure made of aluminium profiles and cast iron parts.
- ▶ Resistencia al viento según la Norma UNE-EN13561:2015. Wind resistance according to Standard UNE-EN 13561:2015

DIMENSIONES MÁXIMAS

Maximum dimensions

Salida/proyección Extension/projection: 3 m
Línea/ancho Line/width: 5 m
Inclinación Angle: 0 to 80°

INSTALACIONES HABITUALES

Standard installations



Ventanas
Windows



Balcones
Balconies



Terrazas
Terraces

ACCIONAMIENTOS

Actuators



Manual
Manual



Motorizado
Motorised

SUJECIÓN

Fastening

TECHO

Roof

FRONTAL

Front

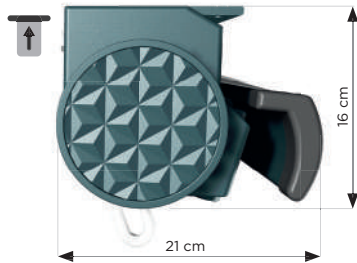

INCLINACIÓN

Angle

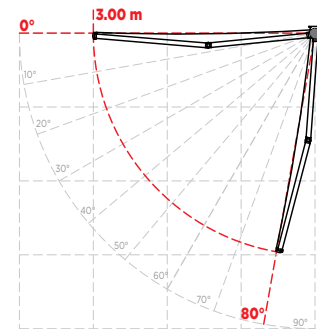

SOPORTE

Surface

Medidas en mm. Measurements in mm.

VISTA FRONTAL

Front view

VISTA SUPERIOR

Top view

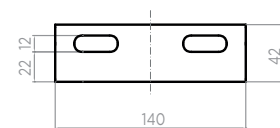
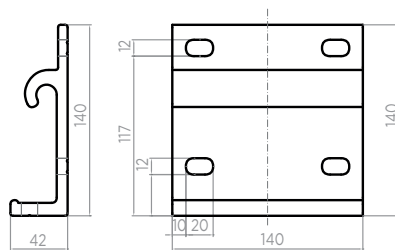

RESISTENCIA AL VIENTO

Wind resistance

| SALIDA DE BRAZO EN METROS Arm extension in metres | LÍNEA EN METROS Line in metres | | | | | |
|--|-----------------------------------|---|-----|---|-----|------------------------|
| | 2,5 | 3 | 3,5 | 4 | 4,5 | 5 |
| 1,5 | CLASE 2 CLASS 2 | | | | | |
| 2 | | | | | | |
| 2,5 | | | | | | |
| 3 | | | | | | |
| | | | | | | CLASE 1 CLASS 1 |

LÍNEA MÍNIMA

Minimum line

| SALIDA Exit (m) | 1.50 | 1.75 | 2.00 | 2.25 | 2.50 | 2.75 | 3.00 |
|-------------------------------|------|------|------|------|------|------|------|
| LÍNEA MÍNIMA Minimum line (m) | 2.10 | 2.35 | 2.60 | 2.85 | 3.10 | 3.35 | 3.60 |



ST. 4

COFRE

CASSETTE

Toldo cofre económico y de pequeñas dimensiones con un innovador diseño exclusivo.

Small, economical box awning with an innovative, exclusive design.

ST. 4 COFRE

CASSETTE



Norma Standard
UNE-EN 13561:2015

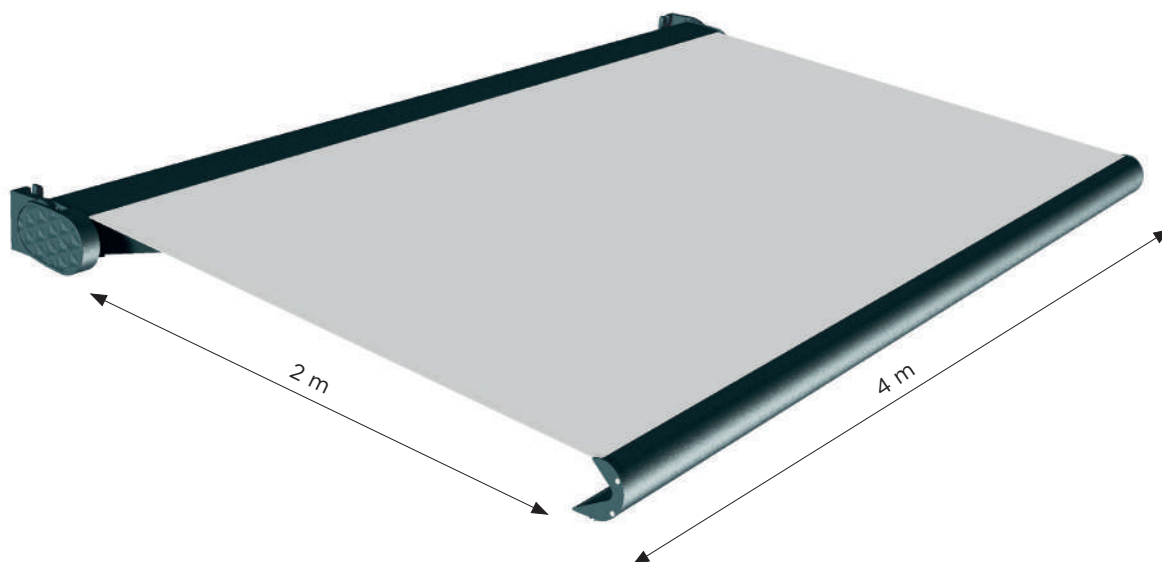

CARACTERÍSTICAS TÉCNICAS

Technical characteristics

CARACTERÍSTICAS

Features

- ▶ Toldo de pequeñas dimensiones. Small awning.
- ▶ Sobrio y elegante, apto para cualquier tipo de construcción. Sober and elegant, suitable for any type of construction.
- ▶ Muy resistente, gracias a su sistema cofre y su construcción con perfilera de aluminio y piezas de fundición. Highly resistant, thanks to its box system and its construction with aluminium sections and cast iron parts.
- ▶ Resistencia al viento según la Norma UNE-EN 13561:2015. Wind resistance according to Standard UNE- EN 13561:2015.

DIMENSIONES MÁXIMAS

Maximum dimensions

Salida/proyección Extension/projection: 2 m
Línea/ancho Line/width: 4 m
Inclinación Angle: 0 to 60°

INSTALACIONES HABITUALES

Standard installations



Ventanas
Windows



Balcones
Balconies



Terrazas
Terraces

ACCIONAMIENTOS

Actuators



Manual
Manual



Motorizado
Motorised

SUJECIÓN

Fastening

■ TECHO

Roof

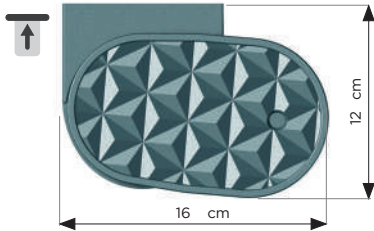

■ FRONTAL

Front

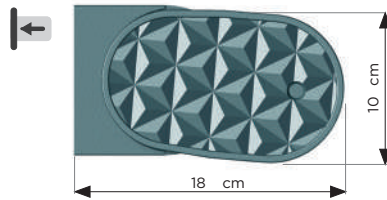

INCLINACIÓN

Angle

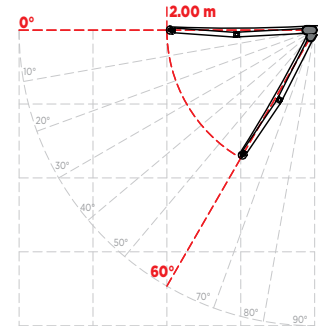

SOPORTE

Surface

Medidas en mm. Measurements in mm.

■ VISTA FRONTAL

Front view

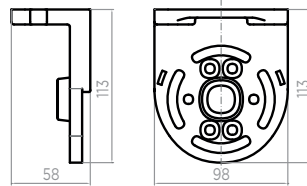

■ VISTA SUPERIOR

Top view

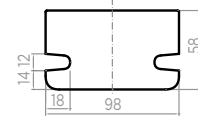

RESISTENCIA AL VIENTO

Wind resistance

| SALIDA DE BRAZO EN METRO Arm extension in metres | LÍNEA EN METROS Line in metres | | | |
|---|-----------------------------------|---|-----|---|
| | 2,5 | 3 | 3,5 | 4 |
| 1,5 | CLASE 2 CLASS 2 | | | |
| 2 | | | | |

LÍNEA MÍNIMA

Minimum line

| SALIDA Exit (m) | 1.25 | 1.50 | 1.75 | 2.00 |
|-------------------------------|------|------|------|------|
| LÍNEA MÍNIMA Minimum line (m) | 1.85 | 2.10 | 2.35 | 2.60 |



ST. 5

COFRE

CASSETTE

Nuevo diseño moderno y actual
de toldo tipo cofre autoportante con
facilidad de montaje.

Self-supporting box awning
with a new modern and contemporary
design and easy assembly.



ST. 5 COFRE

CASSETTE



Norma Standard
UNE-EN 13561:2015

Autoportante
COLGADO RÁPIDO
Self-supporting
QUICK HANG

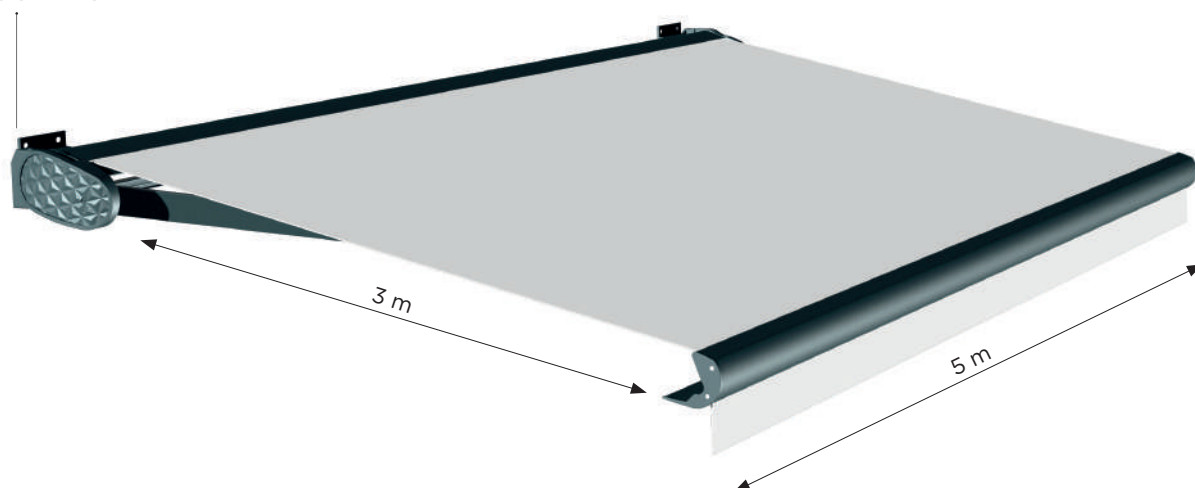

CARACTERÍSTICAS TÉCNICAS

Technical characteristics

CARACTERÍSTICAS

Features

- ▶ Nuevo diseño moderno y actual. New modern and contemporary design.
- ▶ Toldo autoportante con facilidad de montaje. Self-supporting awning with easy assembly.
- ▶ Cofre cerrado. Closed box.
- ▶ Ajuste de la altura lateral de los brazos. Lateral height adjustment of the arms.
- ▶ Resistencia al viento según la Norma UNE-EN 13561:2015. Wind resistance according to Standard UNE-EN 13561:2015.
- ▶ Estructura resistente a la intemperie, perfil de aluminio extruido y pieza de fundición. Weather-resistant structure, extruded aluminium profile and cast iron part.

DIMENSIONES MÁXIMAS

Maximum dimensions

Salida/proyección Extension/projection: 3 m
Línea/ancho Line/width: 5 m
Inclinación Angle: 0 to 60°

INSTALACIONES HABITUALES

Standard installations

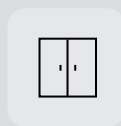

Ventanas
Windows



Balcones
Balconies



Terrazas
Terraces

ACCIONAMIENTOS

Actuators



Manual
Manual



Motorizado
Motorised

SUJECIÓN

Fastening

■ TECHO

Roof

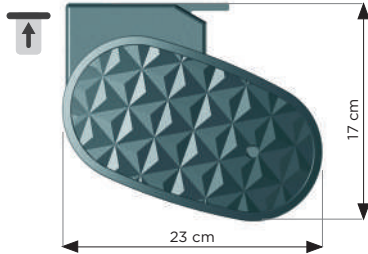

■ FRONTAL

Front

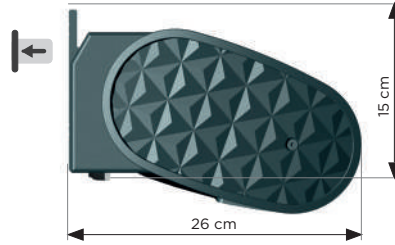

INCLINACIÓN

Angle

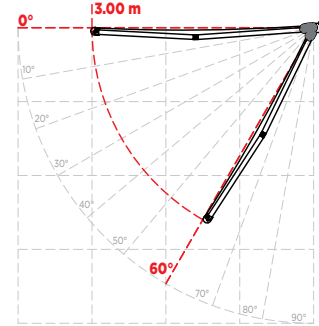

SOPORTE

Surface

Medidas en mm. Measurements in mm.

■ VISTA FRONTAL

Front view

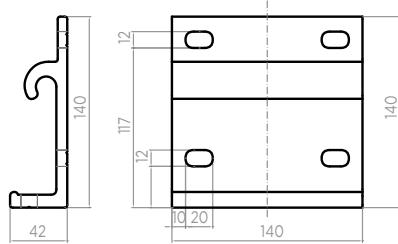

■ VISTA SUPERIOR

Top view

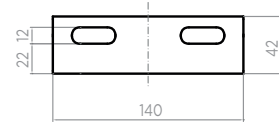

RESISTENCIA AL VIENTO

Wind resistance

| SALIDA DE BRAZO EN METROS Arm extension in metres | LÍNEA EN METROS Minimum line | | | | | |
|---|---------------------------------|---|-----|---|-----|---|
| | 2,5 | 3 | 3,5 | 4 | 4,5 | 5 |
| 2,5 | CLASE 2 CLASS 2 | | | | | |
| 1,75 | | | | | | |
| 2 | | | | | | |
| 2,25 | | | | | | |
| 2,5 | | | | | | |
| 2,75 | | | | | | |
| 3 | | | | | | |

LÍNEA MÍNIMA

Minimum line

| SALIDA Exit (m) | 1.50 | 1.75 | 2.00 | 2.25 | 2.50 | 2.75 | 3.00 |
|-------------------------------|------|------|------|------|------|------|------|
| LÍNEA MÍNIMA Minimum line (m) | 2.10 | 2.35 | 2.60 | 2.85 | 3.10 | 3.35 | 3.60 |



ST. 6

COFRE

CASSETTE

Nuestro cofre que aúna diseño y gran facilidad de montaje.

Our box that combines design and real ease of assembly.



ST. 6 COFRE

CASSETTE



Norma Standard
UNE-EN 13561:2015

Autoportante
COLGADO RÁPIDO
Self-supporting
QUICK HANG

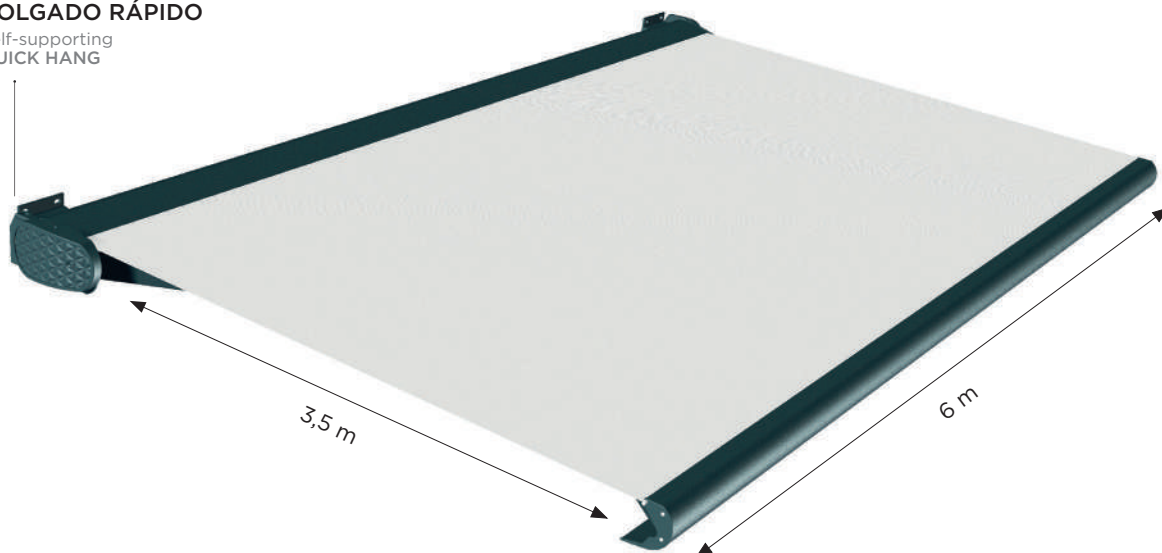

TECHNICAL FEATURES

Technical characteristics

CARACTERÍSTICAS

Features

- ▶ Toldo de gran proyección. Long projection awning.
- ▶ Nuevo diseño moderno y actual. New modern and contemporary design.
- ▶ Toldo autoportante con facilidad de montaje. Self-supporting awning with easy assembly.
- ▶ Caja cerrada para una óptima protección de la lona. Closed box for optimal protection of the fabric.
- ▶ Ajuste de la altura lateral de los brazos. Lateral arm height adjustment
- ▶ Resistencia al viento según la Norma UNE-EN 13561:2015. Wind resistance according to Standard UNE- EN 13561:2015.
- ▶ Estructura resistente a la intemperie, perfil de aluminio extruido y piezas de fundición. Weather-resistant structure, extruded aluminium profile and cast iron parts.

DIMENSIONES MÁXIMAS

Maximum dimensions

Salida/proyección Extension/projection: 35 m
Línea/ancho Line/width: 6 m
Inclinación Angle: 0 to 60°

INSTALACIONES HABITUALES

Standard installations



Ventanas
Windows



Balcones
Balconies

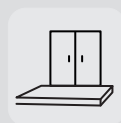

Terrazas
Terraces



Horecas
Hospitality

ACCIONAMIENTOS

Actuators



Manual
Manual



Motorizado
Motorised

SUJECIÓN

Fastening

■ TECHO

Roof

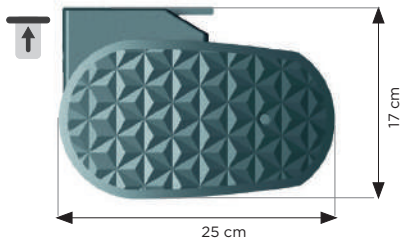

■ FRONTAL

Front

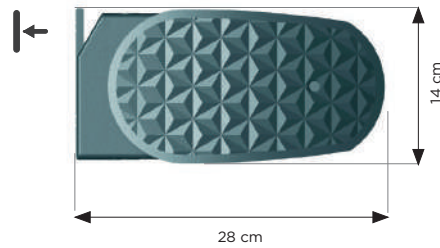

INCLINACIÓN

Angle

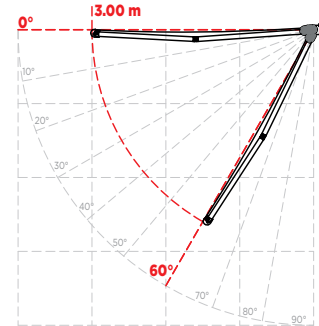

SOPORTE

Surface

Medidas en mm. Measurements in mm.

■ VISTA FRONTAL

Front view

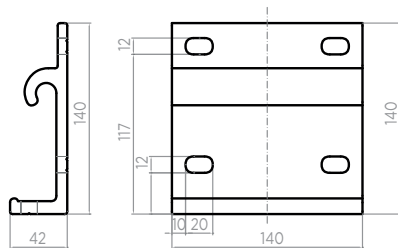

■ VISTA SUPERIOR

Top view

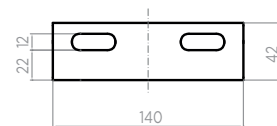

RESISTENCIA AL VIENTO

Wind resistance

| SALIDA DE BRAZO EN METROS Arm extension in metres | LÍNEA EN METROS Line in metres | | | | | | | |
|--|-----------------------------------|---|-----|---|-----|---|-----|---|
| | 2,5 | 3 | 3,5 | 4 | 4,5 | 5 | 5,5 | 6 |
| 1,5 | | | | | | | | |
| 1,75 | | | | | | | | |
| 2 | | | | | | | | |
| 2,25 | | | | | | | | |
| 2,5 | | | | | | | | |
| 2,75 | | | | | | | | |
| 3 | | | | | | | | |
| 3,5 | | | | | | | | |

CLASE 2 CLASS 2

CLASE 1 CLASS 1

LÍNEA MÍNIMA

Minimum line

| SALIDA Exit (m) | 1.50 | 1.75 | 2.00 | 2.25 | 2.50 | 2.75 | 3.00 |
|-------------------------------|------|------|------|------|------|------|------|
| LÍNEA MÍNIMA Minimum line (m) | 2.10 | 2.35 | 2.60 | 2.85 | 3.10 | 3.35 | 3.60 |



ST. 7

MONOBLOC

MONOBLOC

Este toldo autosustentado sobre tubo cuadrado con soporte de brazo remoto es ideal para espacios de gran envergadura.

This self-supporting awning on a square tube with remote arm support is ideal for large spaces.



ST. 7 MONOBLOC

MONOBLOC



Norma Standard
UNE-EN 13561:2015

Soporte de brazo **REMOTO**
REMOTE arm support

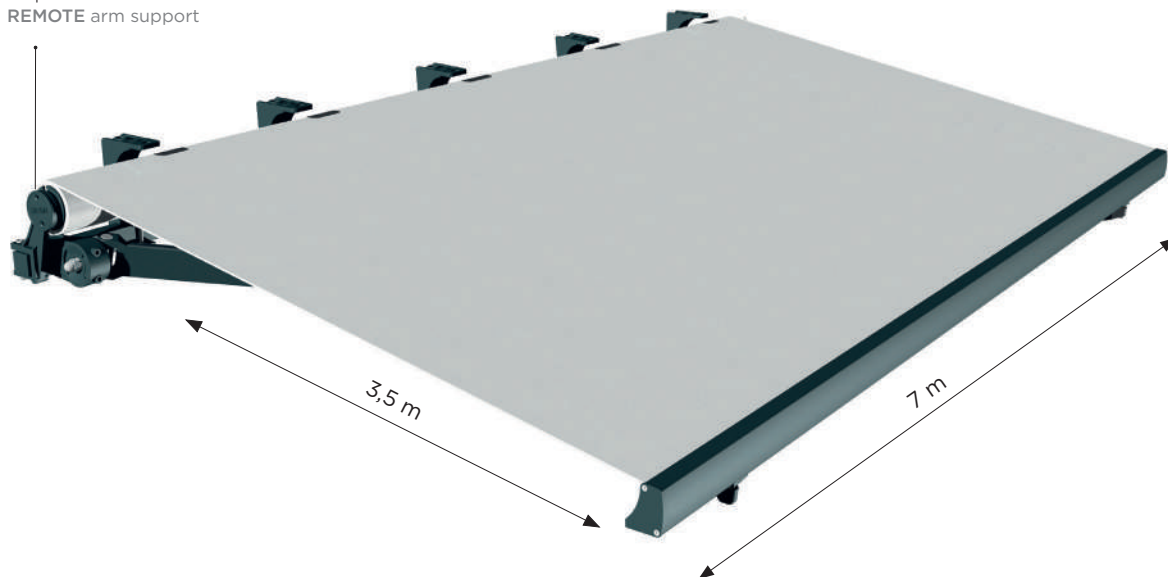

CARACTERÍSTICAS TÉCNICAS

Technical characteristics

CARACTERÍSTICAS

Features

- ▶ Toldo autoportante sobre tubo de acero. Self-supporting awning on steel tube.
- ▶ Soporte de brazo remoto (ideal toldos gran envergadura). Remote arm support (ideal for large awnings).
- ▶ Fijación simplificada con soporte múltiple (fachada y techo). Simplified fixing with multiple support (façade and roof).
- ▶ Ajuste de orientación muy simple con acceso rápido a tornillos de ajuste. Very simple orientation adjustment with quick access to adjustment screws.
- ▶ Resistencia al viento según Norma UNE-EN13561:2015. Wind resistance according to Standard UNE-EN 13561:2015.

DIMENSIONES MÁXIMAS

Maximum dimensions

Salida/proyección Extension/projection: 3.5 m
Línea/ancho Line/width: 7 m
Inclinación Angle: 0 to 90°

INSTALACIONES HABITUALES

Standard installations



Ventanas
Windows



Balcones
Balconies

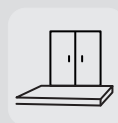

Terrazas
Terraces



Horecas
Hospitality

ACCIONAMIENTOS

Actuators



Manual
Manual



Motorizado
Motorised

SUJECIÓN

Fastening

■ DIFERENTES POSIBILIDADES

Different options

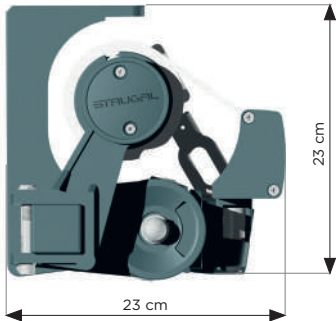

A techo
Mounted to ceiling



Frontal
Front

INCLINACIÓN

Angle

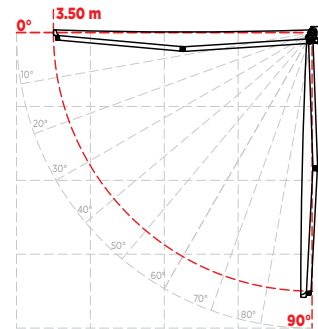

Medidas en mm. Measurements in mm.

SOPORTE

Surface

■ VISTA FRONTAL

Front view

■ VISTA SUPERIOR

Top view

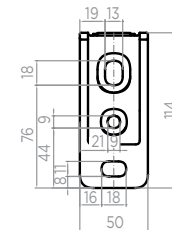
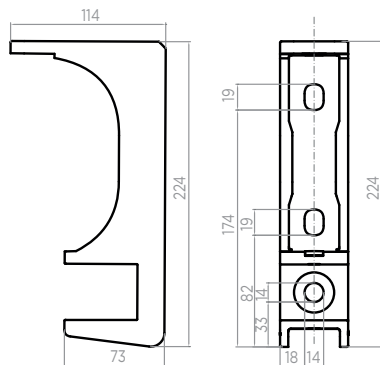

RESISTENCIA AL VIENTO

Windresistance

| SALIDA DE BRAZO EN METROS Arm extension in metres | LÍNEA EN METROS Minimum line | | | | | | | |
|--|--|------|------|-----|-----|------|------|---|
| | 2,5 | 3,02 | 3,62 | 4,2 | 4,8 | 5,37 | 5,98 | 7 |
| 1,5 | <div style="text-align: center;"> <p>CLASE 2 CLASS 2</p> <p>CLASE 1 CLASS 1</p> </div> | | | | | | | |
| 1,75 | | | | | | | | |
| 2 | | | | | | | | |
| 2,25 | | | | | | | | |
| 2,5 | | | | | | | | |
| 2,75 | | | | | | | | |
| 3 | | | | | | | | |
| 3,5 | | | | | | | | |

LÍNEA MÍNIMA

Minimum line

| SALIDA Exit (m) | 1.50 | 1.75 | 2.00 | 2.25 | 2.50 | 2.75 | 3.00 |
|-------------------------------|------|------|------|------|------|------|------|
| LÍNEA MÍNIMA Minimum line (m) | 2.10 | 2.35 | 2.60 | 2.85 | 3.10 | 3.35 | 3.60 |



ST. 9

SCREEN

Con una protección máxima y un ancho máximo de 2,5 metros. Su sistema facilita la instalación tanto en fachadas como en techos.

With maximum protection and a maximum width of 2.5 metres. Its system facilitates installation on façades as well as on roofs.

ST. 9 SCREEN



Norma Standard
UNE-EN 13561:2015



El tejido no entra en el interior de las guías laterles.

The fabric does not enter into the side guides.

CARACTERÍSTICAS TÉCNICAS

Technical characteristics

CARACTERÍSTICAS

Features

- ▶ Toldo vertical con lona oculta. Vertical awning with concealed fabric.
- ▶ Especialmente idóneo para dimensiones reducidas. Particularly suitable for small dimensions.
- ▶ Posibilidad de colocación tanto en fachadas como en techos. Can be installed on façades as well as on roofs.
- ▶ Resistencia al viento según Norma UNE-EN 13561:2015. Wind resistance according to Standard UNE-EN 13561:2015.

DIMENSIONES MÁXIMAS

Maximum dimensions

Salida/proyección Extension/projection: 2.5 m
Línea/ancho Line/width: 2.5 m

INSTALACIONES HABITUALES

Standard installations



Ventanas
Windows



Balcones
Balconies

ACCIONAMIENTOS

Actuators



Motorizado
Motorised

SUJECIÓN

Fastening

■ TECHO

Roof

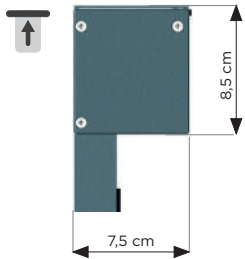

■ FRONTAL

Front

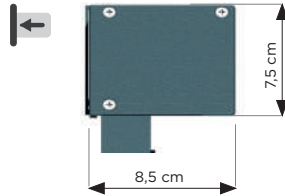

SOPORTE

Surface

Medidas en mm. Measurements in mm.

■ VISTA FRONTAL

Front view

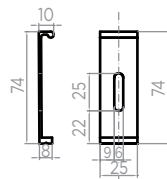

■ VISTA SUPERIOR

Top view



RESISTENCIA AL VIENTO

Wind resistance

| SALIDA EN METROS Extension in metres | LÍNEA EN METROS Line in metres | | | | | | |
|--|-----------------------------------|------|-----|------|---|------|-----|
| | 1 | 1,25 | 1,5 | 1,75 | 2 | 2,25 | 2,5 |
| 0,6 | CLASE 1 CLASS 1 | | | | | | |
| 0,8 | | | | | | | |
| 1 | | | | | | | |
| 1,25 | | | | | | | |
| 1,5 | | | | | | | |
| 1,75 | | | | | | | |
| 2 | | | | | | | |
| 2,25 | | | | | | | |
| 2,5 | | | | | | | |



A photograph of a modern building facade featuring a white, perforated metal screen (ST.10) installed over large glass windows. The building has a clean, minimalist design with white panels and dark window frames. In the background, there are lush green trees and a clear blue sky. The overall scene is bright and contemporary.

ST. 10

SCREEN ZIP

Estructura vertical de diseño, válida tanto para instalación exterior como interior, que permite controlar la incidencia del sol y la temperatura dentro del espacio.

Vertical design structure, suitable for both outdoor and indoor installation, which allows controlling the incidence of the sun and the temperature inside the space.

ST. 10 SCREEN ZIP



Norma Standard
UNE-EN 13561:2015



■ **OPCIÓN
CON TELA MOSQUITERA***
Option with mosquito netting

*Bajo presupuesto.
*Quote required.

CARACTERÍSTICAS TÉCNICAS

Technical characteristics

CARACTERÍSTICAS

Features

► Sistema guiado por cremalleras que hace que la lona se encuentre siempre alojada en el interior de los perfiles laterales consiguiendo importantes valores de resistencia al viento.

Rack and pinion-guided system which ensures that the fabric is always housed inside the side profiles, achieving significant wind resistance levels.

► Estructura que consigue controlar la incidencia solar y la temperatura en el interior de la vivienda/pérgola.

Structure that manages to control sun incidence and temperature inside the house/pergola.

► Posibilidad de instalación en ventanas por el interior o exterior, en espacios y estructuras ya existentes, porticos y pérgolas bioclimáticas o cualquier estructura con forma de rectángulo.

Option of installation on windows on the inside or outside, on existing spaces and structures, bioclimatic porches and pergolas or any structure in the shape of a rectangle.

DIMENSIONES

MÁXIMAS

Maximum dimensions

Salida/proyección Extension/projection: 3 m

Línea/ancho Line/width: 5 m

INSTALACIONES HABITUALES

Standard installations



Ventanas
Windows



Balcones
Balconies



Terrazas
Terraces



Forjado
Slab

ACCIONAMIENTOS

Actuators



Motorizado
Motorised

SUJECCIÓN

Fastening

FRONTAL Front

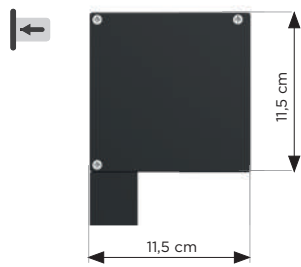

RESISTENCIA AL VIENTO

Wind resistance

| SALIDA EN METROS Extension in metres | LÍNEA EN METROS Line in metres | | | | | | | | | |
|--|-----------------------------------|-----|---|-----|---|-----|---|-----|---|--|
| | 1 | 1,5 | 2 | 2,5 | 3 | 3,5 | 4 | 4,5 | 5 | |
| 1 | CLASE 1 CLASS 1 | | | | | | | | | |
| 1,25 | | | | | | | | | | |
| 1,5 | | | | | | | | | | |
| 1,75 | | | | | | | | | | |
| 2 | | | | | | | | | | |
| 2,25 | | | | | | | | | | |
| 2,5 | | | | | | | | | | |
| 2,75 | | | | | | | | | | |
| 3 | | | | | | | | | | |

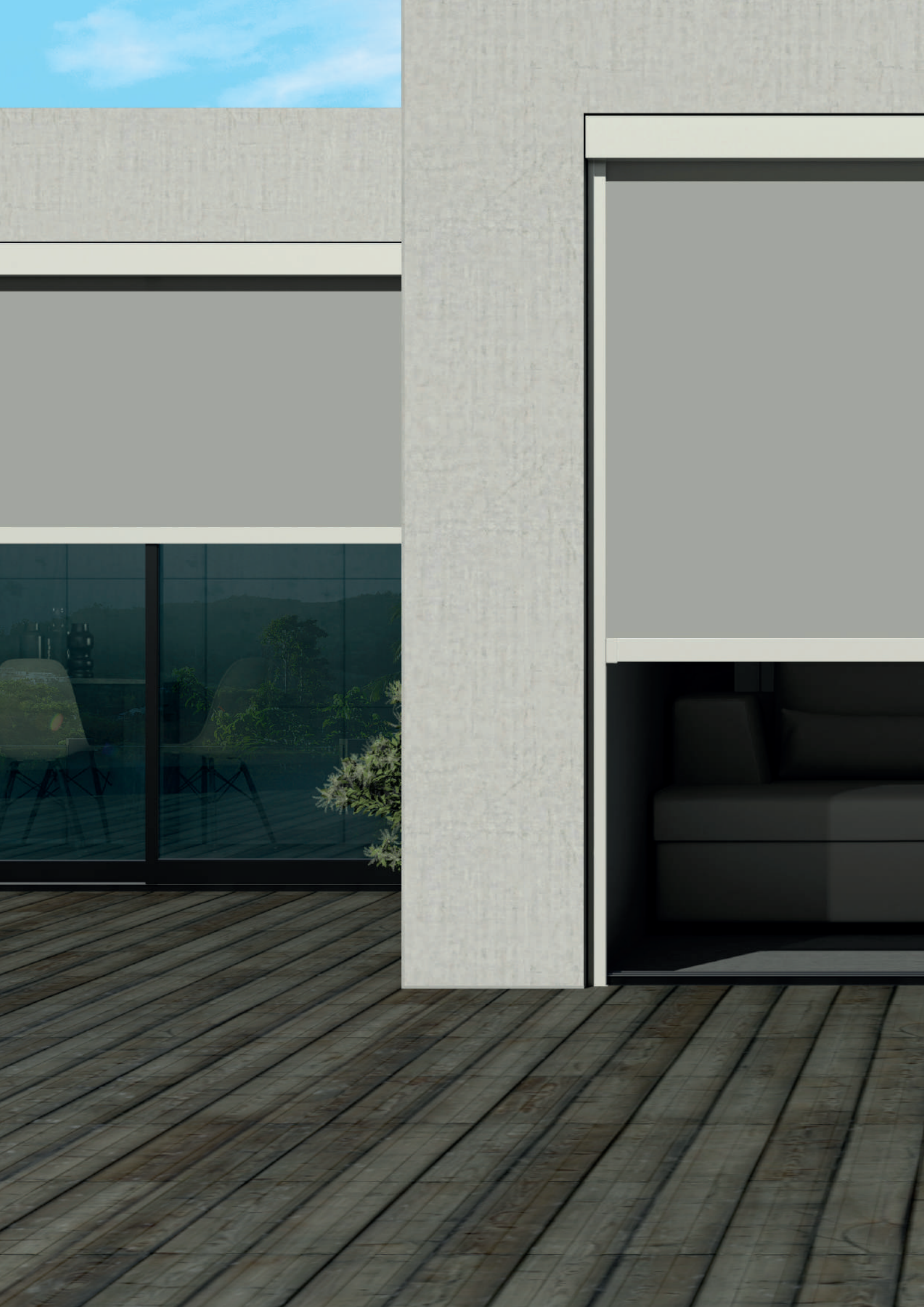

ST. 11

SCREEN

Toldo de amplias dimensiones, ya que cuenta con una proyección máxima de 5 metros y un ancho de 3 metros. Este modelo está pensado para su colocación en fachadas.

Large awning with a maximum projection of 5 metres and a width of 3 metres. This model is designed to be installed on façades.



ST.11 SCREEN



Norma Standard
UNE-EN 13561:2015

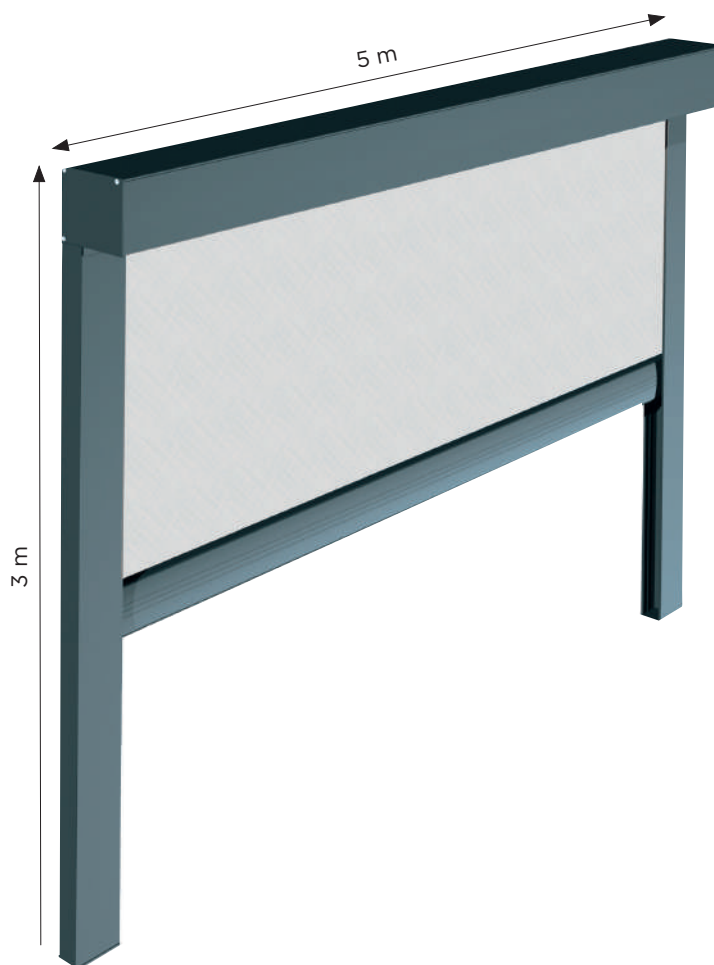

CARACTERÍSTICAS TÉCNICAS

Technical characteristics

CARACTERÍSTICAS

Features

- ▶ El toldo vertical con guías y lona oculta es un sistema de bajada guiado mediante perfil-guía en U de aluminio, que incluye cerrojos para fijar y tensar el tejido. The vertical awning with guides and concealed fabric is a guided lowering system using an aluminium U-shaped guide profile, which includes bolts for fixing and tensioning the fabric.
- ▶ Resistencia según Norma UNE-EN 13561:2015. Resistance according to Standard UNE-EN 13561:2015.

DIMENSIONES MÁXIMAS

Maximum dimensions

Salida/proyección Extension/projection: 3 m
Línea/ancho Line/width: 5 m

INSTALACIONES HABITUALES

Standard installations



Ventanas
Windows



Balcones
Balconies

ACCIONAMIENTOS

Actuators



Motorizado
Motorised

SUJECIÓN

Fastening

FRONTAL

Front

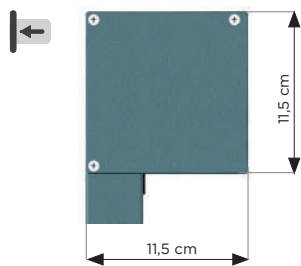

RESISTENCIA AL VIENTO

Wind resistance

| SALIDA EN METROS Extension in metres | LÍNEA EN METROS Line in metres | | | | | | | | | |
|--|-----------------------------------|------|-----|------|---|------|-----|------|---|--|
| | 1 | 1,25 | 1,5 | 1,75 | 2 | 2,25 | 2,5 | 2,75 | 3 | |
| 1 | CLASE 1 CLASS 1 | | | | | | | | | |
| 1,5 | | | | | | | | | | |
| 2 | | | | | | | | | | |
| 2,5 | | | | | | | | | | |
| 3 | | | | | | | | | | |
| 3,5 | | | | | | | | | | |
| 4 | | | | | | | | | | |
| 4,5 | | | | | | | | | | |
| 5 | | | | | | | | | | |

ST. 12

CORTAVIENTO / TELÓN VERTICAL

WINDBREAK / VERTICAL CURTAIN

Estructura que ayuda a crear un ambiente cálido y acogedor, a la vez que confortable.

Structure that helps to create a warm, cosy and comfortable atmosphere.





ST.12 CORTAVIENTO / TELÓN VERTICAL

WINDBREAK / VERTICAL CURTAIN



Norma Standard
UNE-EN 13561:2015



CARACTERÍSTICAS TÉCNICAS

Technical characteristics

CARACTERÍSTICAS

Features

- ▶ Estructura utilizada donde se requiere una protección integral. Structure used where comprehensive protection is required.
- ▶ Diseñado para da sombra de forma vertical y separar estancias. Designed to provide vertical shade and separate rooms.
- ▶ Su función principal es la de proteger del viento en la zona interior de la estructura. Its main function is to protect the interior of the structure from the wind.
- ▶ Incorporación de perfiles divisores para ofrecer mayor resistencia. Incorporation of dividing profiles for greater strength.
- ▶ Posibilidad de crear zona de visión mediante ventana transparente en el propio tejido. Option of creating a viewing area via a transparent window in the fabric itself.

DIMENSIONES MÁXIMAS

Maximum dimensions

Salida/proyección Extension/projection: 3 m
Línea/ancho Line/width: 4.8 m

INSTALACIONES HABITUALES

Standard installations



Terrazas
Terraces



Forjado
Slab

ACCIONAMIENTOS

Actuators



Manual
Manual



Motorizado
Motorised

SUJECIÓN

Fastening

■ TECHO

Roof

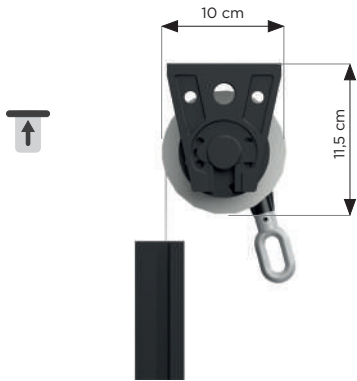

■ FRONTAL/ENTRE PAREDES

Front / Between walls

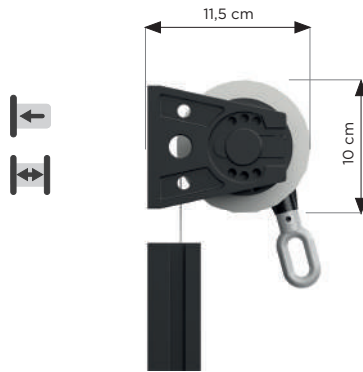

SOPORTE

Surface

Medidas en mm. Measurements in mm.



■ VISTA FRONTAL

Front view

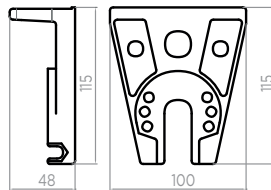

■ VISTA SUPERIOR

Top view

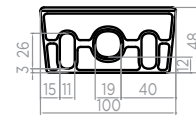

RESISTENCIA AL VIENTO

Wind resistance

| SALIDA EN METROS Extension in metres | LÍNEA EN METROS Line in metres | | | | | | | | | |
|--|-----------------------------------|-----|---|-----|---|-----|---|-----|-----|--|
| | 1 | 1,5 | 2 | 2,5 | 3 | 3,5 | 4 | 4,5 | 4,8 | |
| 1 | CLASE 1 CLASS 1 | | | | | | | | | |
| 1,25 | | | | | | | | | | |
| 1,5 | | | | | | | | | | |
| 1,75 | | | | | | | | | | |
| 2 | | | | | | | | | | |
| 2,25 | | | | | | | | | | |
| 2,5 | | | | | | | | | | |
| 2,75 | | | | | | | | | | |
| 3 | | | | | | | | | | |

ST. 15

DOBLE

DOUBLE

Este toldo comúnmente conocido como «doble pendiente» es ideal para proteger la terraza de una cafetería o restaurante por su gran envergadura y la posibilidad de fijarse en el suelo.

This awning, commonly known as "double slope", is ideal for protecting the terrace of a café or restaurant due to its large span and the option of fixing it to the ground.





ST. 15 DOBLE

DOUBLE



Norma Standard
UNE-EN 13561:2015



CARACTERÍSTICAS TÉCNICAS

Technical characteristics

CARACTERÍSTICAS

Features

- ▶ Gran envergadura y "doble pendiente", ideal para proteger la terraza de un espacio público por su gran envergadura. Large span and "double slope", ideal for protecting the terrace of a public space due to its large span.
- ▶ Posibilidad de fijar en el suelo. Can be fixed to the ground.
- ▶ Lona protegida gracias al cofre. Fabric protected by the box.
- ▶ Hasta 36 m² de protección solar. Up to 36m² of sun protection.
- ▶ Resistencia al viento según Norma UNE-EN 13561:2015. Wind resistance according to Standard UNE-EN 13561:2015.

DIMENSIONES MÁXIMAS

Maximum dimensions

Salida/proyección Extension/projection: (2x) 3 m
Línea/ancho Line/width: 6 m
Inclinación Angle: 0 to 20°

INSTALACIONES HABITUALES

Standard installations



Horecas
Hospitality



Grandes espacios
Large spaces

ACCIONAMIENTOS

Actuators



Manual
Manual



Motorizado
Motorised

SUJECIÓN

Fastening

■ SUELO

Floor

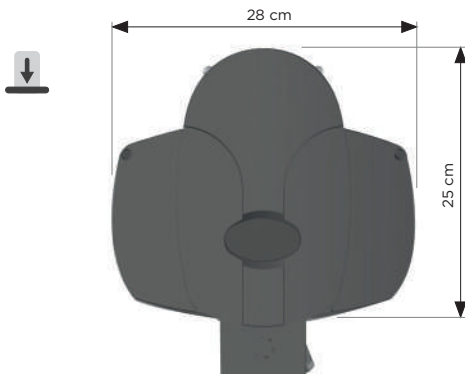

INCLINACIÓN

Angle

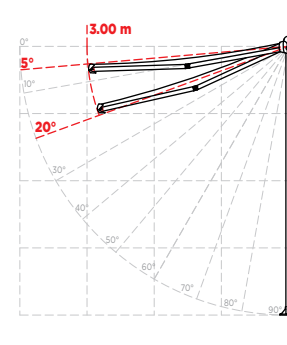

SOPORTE

Surface

Medidas en mm. Measurements in mm.

■ VISTA FRONTAL

Front view

■ VISTA SUPERIOR

Top view

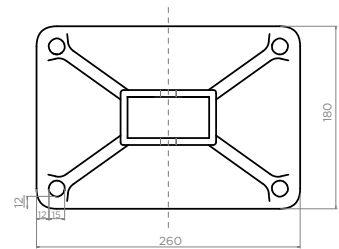
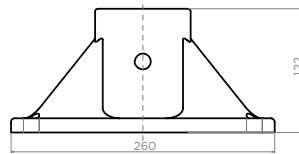
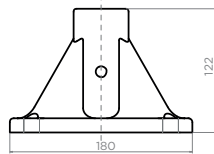
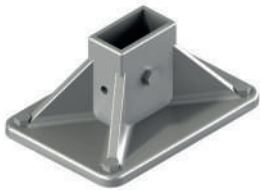

RESISTENCIA AL VIENTO

Wind resistance

| SALIDA DE BRAZO EN METROS Arm extension in metres | LÍNEA EN METROS Line in metres | | | | | | | |
|--|-----------------------------------|---|-----|---|-----|---|-----|---|
| | 2,5 | 3 | 3,5 | 4 | 4,5 | 5 | 5,5 | 6 |
| 1,25 | CLASE 2 CLASS 2 | | | | | | | |
| 1,5 | | | | | | | | |
| 1,75 | | | | | | | | |
| 2 | | | | | | | | |
| 2,25 | | | | | | | | |
| 2,5 | | | | | | | | |
| 2,75 | | | | | | | | |
| 3 | | | | | | | | |

LÍNEA MÍNIMA

Minimum line

| SALIDA Exit (m) | 1.50 | 1.75 | 2.00 | 2.25 | 2.50 | 2.75 | 3.00 |
|-------------------------------|------|------|------|------|------|------|------|
| LÍNEA MÍNIMA Minimum line (m) | 2.10 | 2.35 | 2.60 | 2.85 | 3.10 | 3.35 | 3.60 |



ST. 20

PÉRGOLA

PERGOLA

Nuestro sistema de toldo plano
para amplias superficies.

Our flat awning system
for large areas.



ST.20 PÉRGOLA

PERGOLA



Norma Standard
UNE-EN 13561:2015

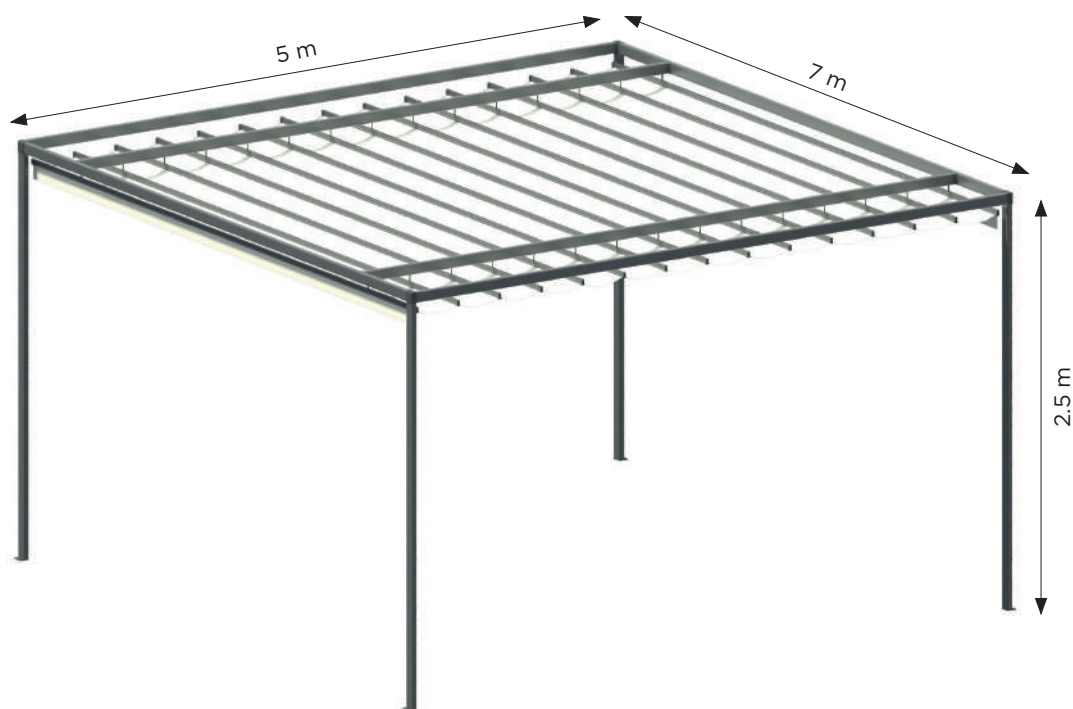

CARACTERÍSTICAS TÉCNICAS

Technical characteristics

CARACTERÍSTICAS

Features

► Sistema de toldo plano basado en perfil estructural 80x40 y ensamblaje mediante componentes estructurales de aluminio. Flat awning system based on 80x40 structural profile and assembly via aluminium structural components.

► Posibilidad de cubrir grandes superficies. Option of covering large areas.

DIMENSIONES

MÁXIMAS

Maximum dimensions

Salida/proyección Extension/projection: 5 m

Línea/ancho Line/width: 7 m

Alto High: 2.5 m

INSTALACIONES HABITUALES

Standard installations



Terrazas
Terraces

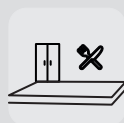

Balcones
Balconies



Grandes espacios
Large spaces

ACCIONAMIENTOS

Actuators



Manual
Manual

SUJECIÓN

Fastening

■ SUELO

Floor

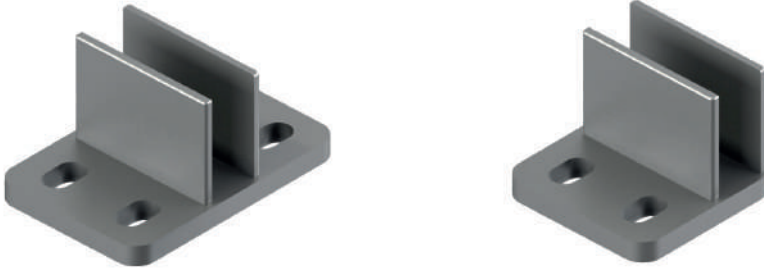

SOPORTE

Surface

Medidas en mm. Measurements in mm.

■ VISTA FRONTAL

Front view

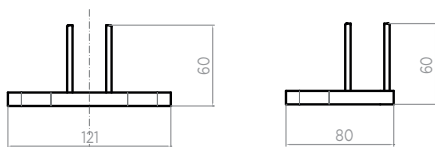

Entreparedes
Between walls

Frontal-Suelo
Front-Ground

■ VISTA SUPERIOR

Top view

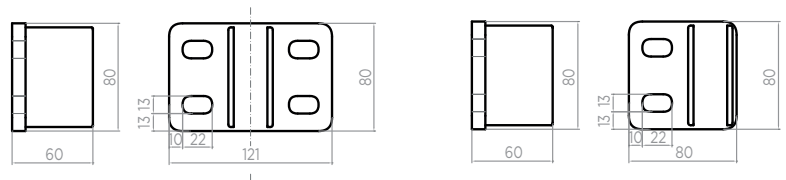

Entreparedes
Inter-wall

Frontal-Suelo
Front-Ground

OPCIONES DE INSTALACIÓN

Installation options

■ INSTALACIÓN ENTRE PAREDES

Inter-wall installation

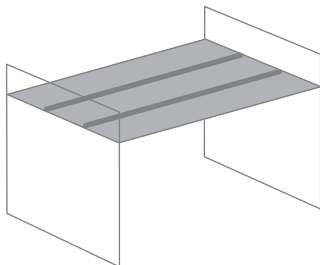

■ INSTALACIÓN "PORTERÍA CON LARGUEROS"

Installation : "goal with rails"

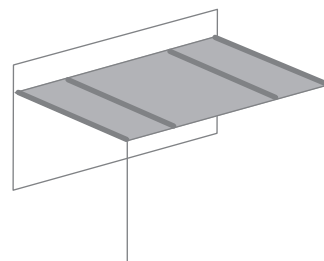

■ INSTALACIÓN "PORTERÍA SIN LARGUEROS"

Installation : "goal without rails"

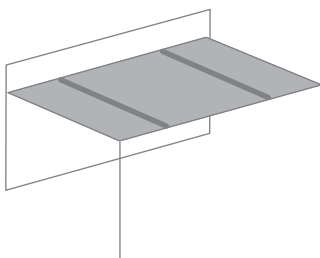

■ INSTALACIÓN "DOBLE PORTERÍA CON LARGUEROS"

Installation: "double goal with crossbars"

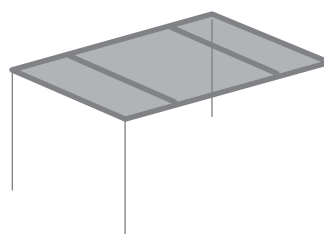

ST.20 ACCESORIOS Y PERFILES

ACCESSORIES AND PROFILES

ST.20 ACCESORIOS PÉRGOLA Pergola accessories

Polea doble
Double pulley

Polea doble pequeña
Small double pulley

Atacuerda pared
Wall binder

Atacuerda
Binder

Soporte frontal 80x40
Front support 80x40

Tapón palillera
Grid cap

Polea móvil con rodamiento blanca
White rolling pulley with bearing

Soporte suelo 4 cogidas
Floor stand with 4 brackets

Juego angular 80x40
Angle set 80x40

ST.20 ACCESORIOS OPCIONALES PÉRGOLA

Pergola optional accessories

Soporte T
T bracket

Brida
Flange

Articulación
Articulation

Soporte suelo 2 cogidas
Floor stand with 2 brackets

Polea larga
Long pulley

ST.20 PERFILES Profiles

Palillera doble
Double grid

Perfil 80*40
Profile 80x40

Perfil guía
Guide rail





ST. 21

CORTINA LATERAL

SIDE CURTAIN

Estructura de lona de desplazamiento lateral que ayuda a proteger la estancia de la luz y las altas temperaturas.

Lateral displacement fabric structure that helps to protect the room from light and high temperatures.



ST.21 CORTINA LATERAL

SIDE CURTAIN



Norma Standard
UNE-EN 13561:2015



CARACTERÍSTICAS TÉCNICAS

Technical characteristics

CARACTERÍSTICAS

Features

- ▶ Estructura utilizada para cubrir aquellas partes del toldo instalado que por su propia fisonomía no puede hacerlo. Structure used to cover the parts of the installed awning that, due to its own physiognomy, cannot do so.
- ▶ Desplazamiento lateral sobre una guía protegiendo de la iluminación y de las altas temperaturas el interior de la estructura formada entre cortina y toldo. Lateral displacement on a guide that protects the interior of the structure formed between the curtain and the awning from light and high temperatures.
- ▶ Formada por un carril de aluminio del que se suspenden unos rodamientos que sujetan la propia lona mediante unos ollaos metálicos. Formed by an aluminium rail from which bearings are suspended that hold the fabric via metal eyelets.

DIMENSIONES MÁXIMAS

Maximum dimensions

Línea/ancho Line/width: 5 m
Alto High: 3 m

INSTALACIONES HABITUALES

Standard installations



Ventanas
Windows



Balcones
Balconies



Terrazas
Terraces



Forjado
Slab

ACCIONAMIENTOS

Actuators



Manual
Manual

SUJECIÓN

Fastening

■ VISTA LATERAL

Side view

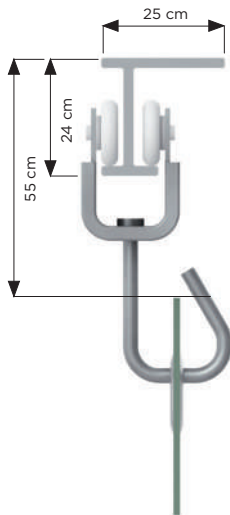

■ POLEA

Pulley



SISTEMA COMPLETO

Complete system

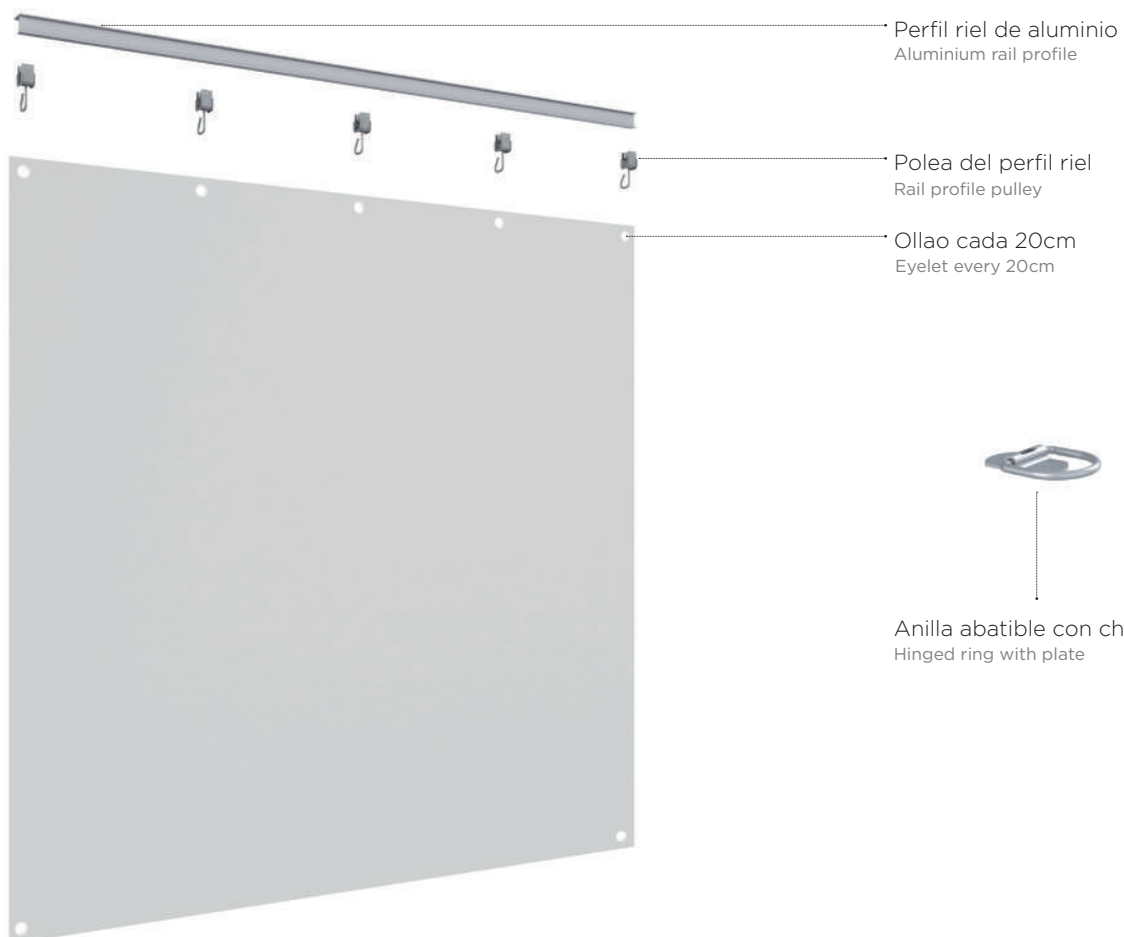

ACABADOS ESTÁNDAR POR ESTRUCTURA

STANDARD FINISHES PER STRUCTURE

ALUMINIO

Aluminium



RAL 7011 TEXTURADO

- ST1 Stor
- ST1 Brazo acodado con tensión
- ST3
- ST5
- ST20 (RAL 7011 Brillo, no texturado / Glossy, not textured)



RAL 7016 TEXTURADO

- ST1 Stor
- ST1 Brazo acodado con tensión
- ST2
- ST3
- ST4
- ST5
- ST6
- ST7
- ST8
- ST9
- ST10
- ST11
- ST12
- ST20 (RAL 7016 Brillo, no texturado / Glossy, not textured)
- TEJADILLO

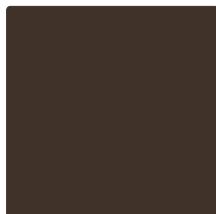

RAL 8014 TEXTURADO

- ST1 Stor
- ST1 Brazo acodado con tensión
- ST3
- ST5
- ST6
- ST12
- ST20 (RAL 8014 Brillo, no texturado / Glossy, not textured)



RAL 9005 TEXTURADO

- ST1 Stor
- ST1 Brazo acodado con tensión
- ST3
- ST5
- ST6
- ST7
- ST10
- ST12
- ST20 (RAL 9005 Brillo, no texturado / Glossy, not textured)
- ST21
- TEJADILLO

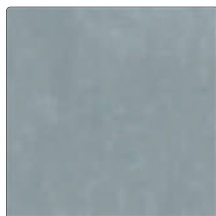

RAL 9006 TEXTURADO

- ST1 Stor
- ST1 Brazo acodado con tensión
- ST3
- ST5
- ST20 (RAL 9006 Brillo, no texturado / Glossy, not textured)

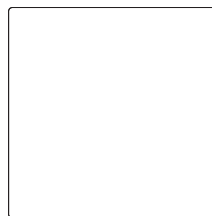

RAL 9016 BRILLO

Todos los modelos
All models

OTROS ACABADOS BAJO PEDIDO
OTHER FINISHES ON REQUEST

TEJIDOS ACRÍLICOS

Acrylic fabrics

■ LONA | LISOS

Canvas | Smooth

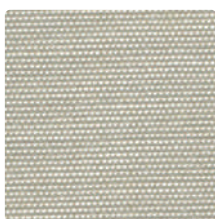

2143
MARFIL

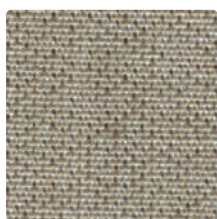

2226
SIROCO

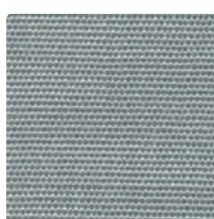

2979
PERLA

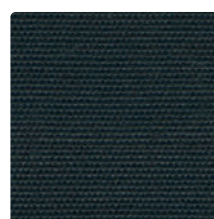

2170
NEGRO

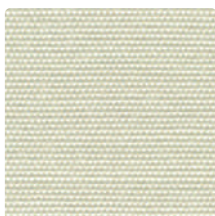

2926
NATURAL



2354
TENERE

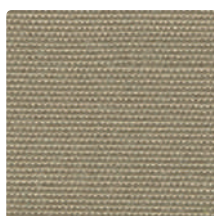

2038
BEIGE

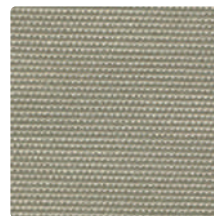

2296
AVENA

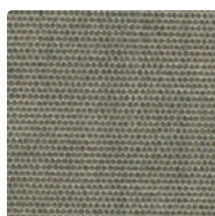

2838
INTEGRAL

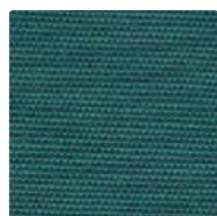

VERDE
2242

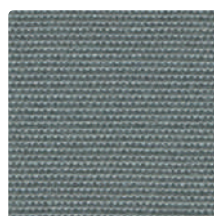

2102
GRIS

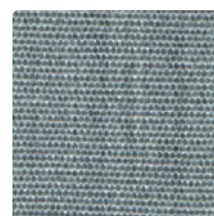

3605
PIEDRA

TEJIDOS ACRÍLICOS

Acrylic fabrics

■ LONA | LISOS

Canvas | Smooth

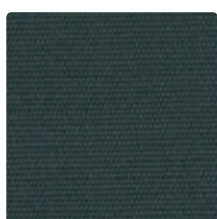

8488
ANTRACITA



2821
SILVER



2042
BLANCO



2596
SEDA

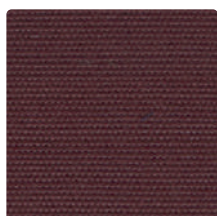

2101
GRANATE

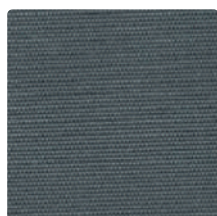

2327
BASALTO

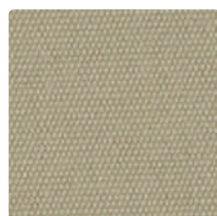

2826
CHAMPAGNE

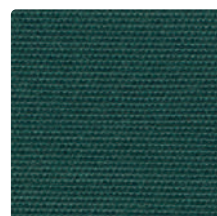

2245
BOTELLA



2013
AMARILLO

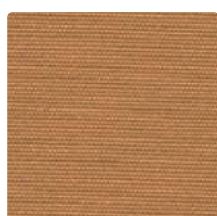

2180
OCRE



2235
AZUL REAL



2141
MAIZ



2834
TOFFEE

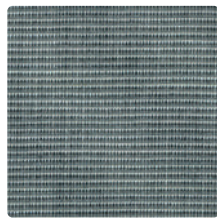

3581
TWEED GRIS CLARO



2687
VAINILLA



8157
ALABASTRO

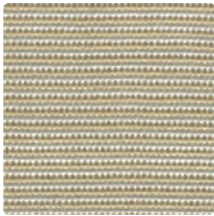

3603
GOBI

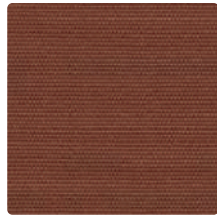

2065
TEJA



2041
BERNA



2146
MARRÓN



2210
RIOJA

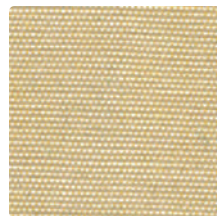

2322
CREMA



2018
AZUL

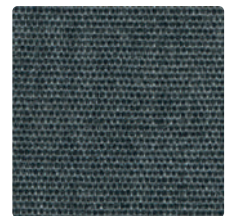

3602
GRAFITO

TEJIDOS ACRÍLICOS

Acrylic fabrics

■ LONA | LISTADOS

Canvas | Striped

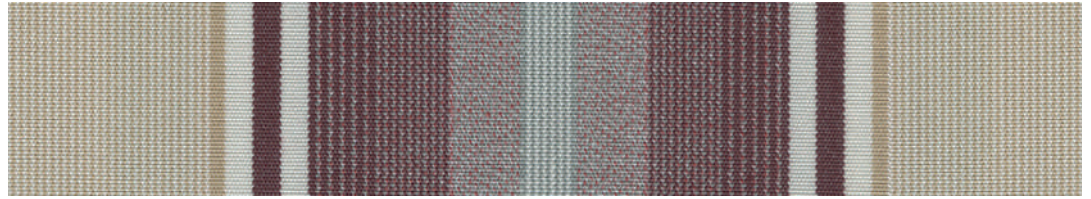
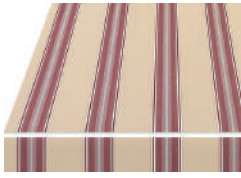

SIENA
2223

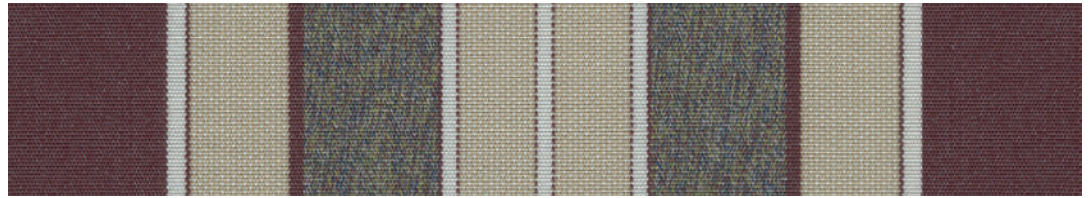
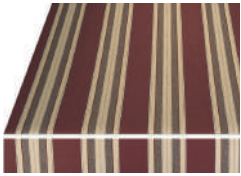

MARTE
2121

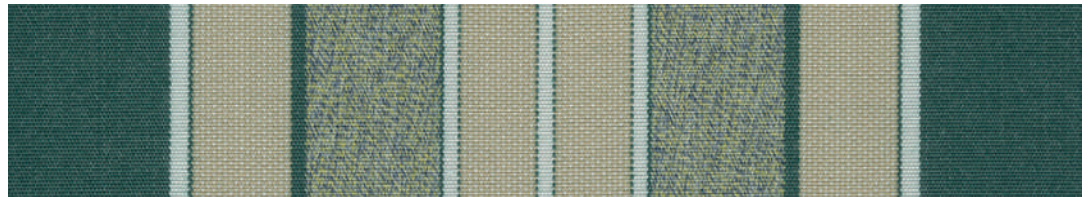
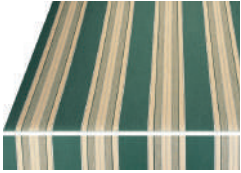

PLUTÓN
2179

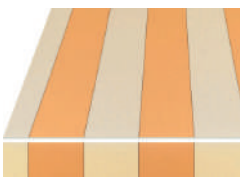

DAKAR
2080

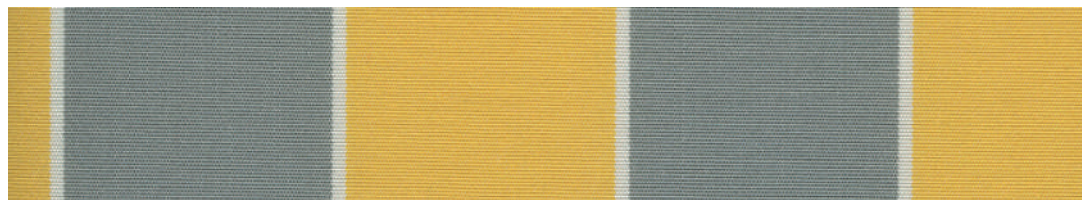
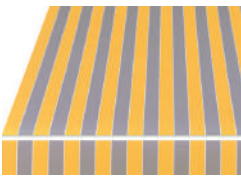

MONACO
2154

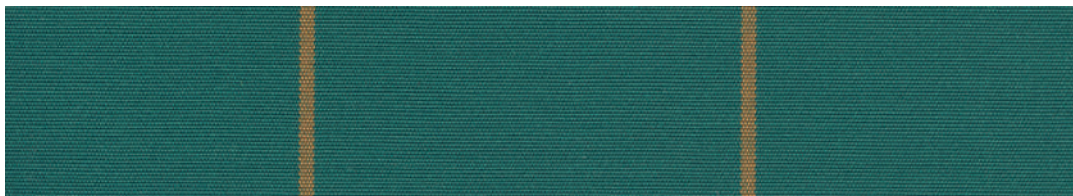

TAMESIS
2231

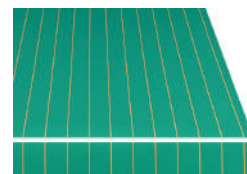

ALSACIA
2031



TAJO
2230

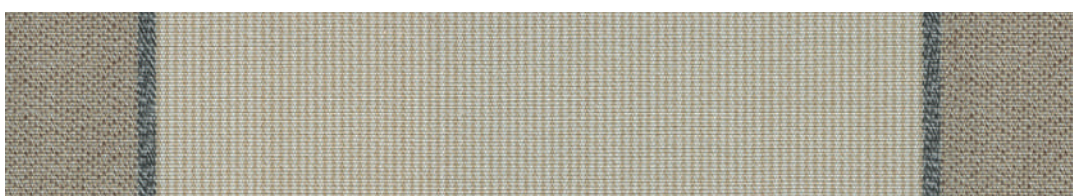

TEXAS
2238



PARMA
2207



TEJIDOS ACRÍLICOS

Acrylic fabrics

■ LONA | LISTADOS

Canvas | Striped



AMARILLO/N
2015



TOPACIO
2233

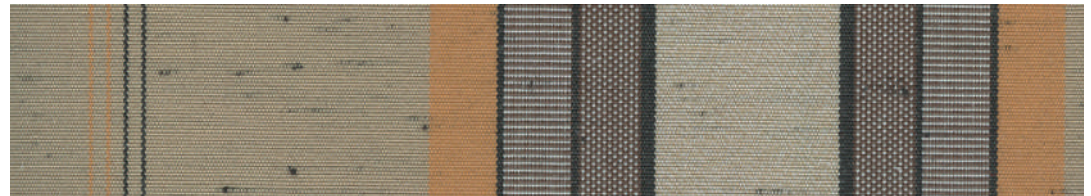
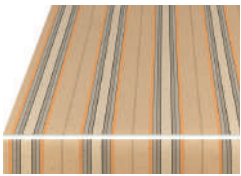

SAHARA
2220

■ LONA | ESTAMPADOS

Canvas | Prints

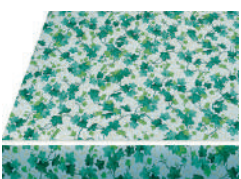

PARADIS
4148

TEJIDOS TÉCNICOS

Technical fabrics

■ SOLTIS 96

Soltis 96

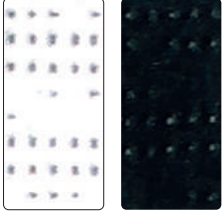

BLANCO
96-8102

NEGRO
96-8450

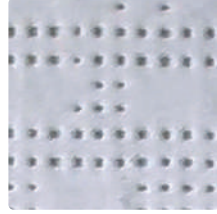

KARITÉ
96-50843



BLANCO ROTO
96-1103

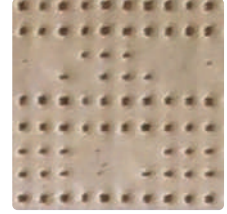

ARENA
96-8861



BEIGE ARENA
96-2135



TOPO
96-50850

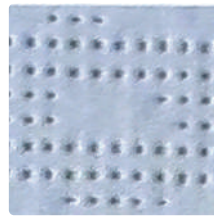

NUBE
96-50272

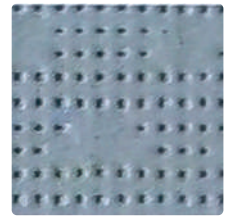

PIEDRA
96-2171

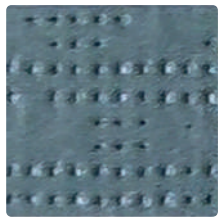

PLATINO
96-50844

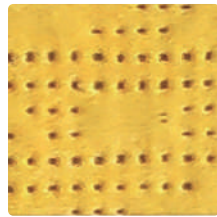

AUREOLINA
96-50845



CARAMELO
96-50261

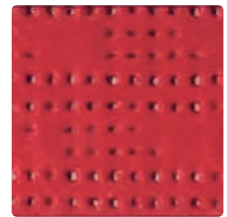

ROJO
96-8255

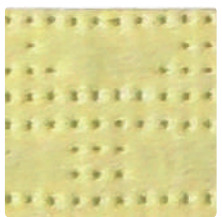

CÍTRICO
96-50846



TILO
96-50848



JUNGLA
96-50849

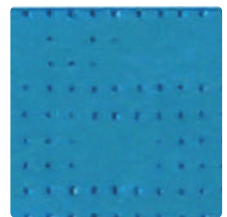

ACAPULCO
96-50847

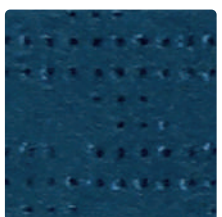

ATLÁNTIDA
96-50851

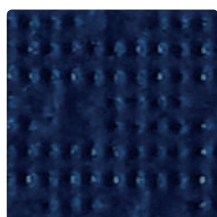

AZUL NOCHE
96-2161



BRONCE
96-2043



ANTRACITA
96-2047

TEJIDOS TÉCNICOS

Technical fabrics

- LONA PVC “MONZA”
“MONZA” PVC fabric

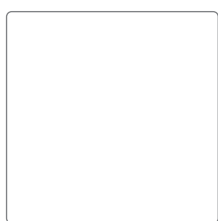

BLANCO

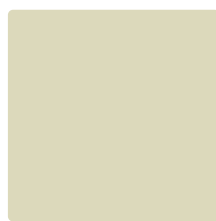

MARFIL



BEIGE



GRIS CLARO



NEGRO

LONAS

FABRICS

| METRAJE DE LONA Fabric in m |
|---|
| Lona Acrílica (ancho 1.200mm) Acrylic fabric (width) |
| PVC estandar (ancho 1.500mm) Standard PVC (width) |
| Lona Acrílica NO estandar. (ancho 1.200mm) Acrylic fabric NON-standard (width) |
| Lona PVC NO estandar. (ancho 1.500mm) PVC fabric NON-standard (width) |
| Lona técnica Soltis 96 (ancho 2670mm) Soltis 96 technical fabric (width) |

| METRAJE DE LONA CONFECCIONADA Made fabric in m |
|---|
| Lona Acrílica (ancho 1.200mm) Acrylic fabric (width) |
| PVC estandar (ancho 1.500mm) Standard PVC (width) |
| Lona Acrílica NO estandar. (ancho 1.200mm) Acrylic fabric NON-standard (width) |
| Lona PVC NO estandar. (ancho 1.500mm) PVC fabric NON-standard (width) |
| Lona técnica Soltis 96 (ancho 2670mm) Soltis 96 technical fabric (width) |
| Incremento por mano de obra palillera simple Labour increment for simple grid work |
| Incremento por mano de obra palillera doble Labour increment for double grid work |

Las medidas se redondearán en tramos 500mm.
Mínimo a factura 2,00 metros.
Measurements will be rounded off in 500mm sections
Minimum billable: 2.00 metres.



PÉRGOLAS

BLOCCIN



BIOCLIMATIC PERGOLAS

ST LIBERTIA

PÉRGOLA BIOCLIMÁTICA ASSEMBLY INSTRUCTIONS

Nuestra pérgola más avanzada. Genera espacios habitables en cualquier estación del año. El sol o la lluvia ya no son inconvenientes.

Our most advanced pergola. It creates living spaces in any season of the year. Sun or rain are no longer a problem.





ST LIBERTIA

PÉRGOLA BIOCLIMÁTICA

ASSEMBLY INSTRUCTIONS



Norma Standard
UNE-EN 13561:2015

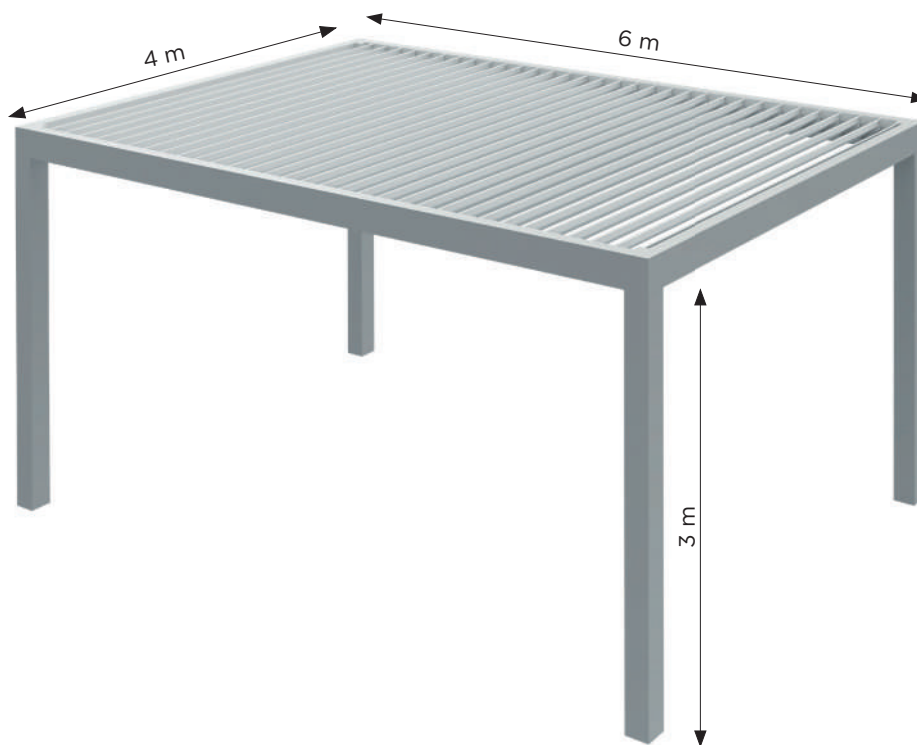

CARACTERÍSTICAS TÉCNICAS

Technical characteristics

CARACTERÍSTICAS

Features

- ▶ Estructura de aluminio con lamas móviles motorizadas. Aluminium structure with motorised movable slats.
- ▶ Pilares y estructura registrables y sin tornillería vista. Adjustable pillars and structure without visible screws.
- ▶ Proporciona sombra eficiente, control de la luz y de fácil adaptación. Provides efficient shading, light control and easy adaptability.
- ▶ Las lamas cerradas protegen de la lluvia permitiendo, espacios habitables en varias estaciones. Closed slats protect from rain, allowing for multi-season living spaces.
- ▶ Drenajes y conductos de instalación eléctrica ocultos. Hidden drains and electrical lines.
- ▶ Motorización completamente oculta. Completely concealed motorisation.
- ▶ Domótica. Posibilidad de automatización, iluminación (focos o LED), sensores solares, lluvia y viento. Home automation. Possibility of automation, lighting (spotlights or LEDs), solar, rain and wind sensors.

DIMENSIONES MÁXIMAS POR MÓDULO

Maximum dimensions per module

Salida/proyección Extension/projection: 6 m
Línea/ancho Line/width: 4 m
Altura máxima Maximum height: 3 m
Inclinación Angle: lamas orientables de of adjustable slats from: 0° to 120°

INSTALACIONES HABITUALES

Standard installations



Terrazas
Terraces



Horecas
Hospitality



Grandes espacios
Large spaces

ACCIONAMIENTOS

Actuators



Motorizado
Motorised

SUJECCIÓN

Fastening

Nuestras pérgolas bioclimáticas son fabricadas a medida, y poseen varias tipologías de montaje para adaptarse al espacio y necesidades. En todos los casos, son resistentes a la intemperie, con carcasa de aluminio o acero inoxidable.

Our bioclimatic pergolas are made to measure, and have various types of assembly to adapt to the space and needs. In all cases, they are weatherproof, with aluminium or stainless steel housing.

■ SIN ESTRUCTURA

No structure



■ FIJACIÓN FACHADA 2 VIGAS LATERALES

Facade fixing 2 side beams



■ FIJACIÓN FACHADA 2 VIGAS LATERALES (DUPLEX)

Facade fixing 2 lateral beams (duplex)



■ CON ESTRUCTURA 2 PILARES

With 2-pillar structure

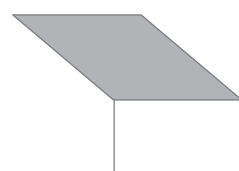

■ CON ESTRUCTURA 2 PILARES (DUPLEX)

With 2-pillar structure (duplex)

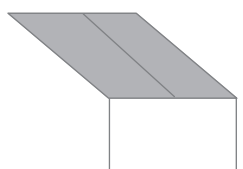

■ CON ESTRUCTURA 4 PILARES

With 4-pillar structure

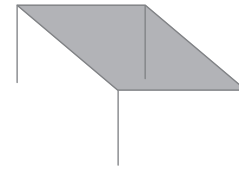

■ CON ESTRUCTURA 4 PILARES (DUPLEX)

With 4-pillar structure (duplex)

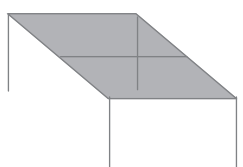

■ CON PILARES INTERMEDIOS

With intermediate pillars

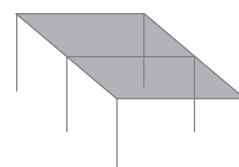



DOMÓTICA Y MOTORES



HOME AUTOMATION AND **MOTORISATION**

DOMÓTICA Y MOTORIZACIÓN

HOME AUTOMATION AND MOTORISATION

MOTORIZACIÓN

MOTORISATION

Motor con final de carrera electrónico y receptor incorporado, para la automatización de persianas y toldos.

Contamos con una amplia gama de motores que dan versatilidad funcional para tus sistemas de persianas y toldos:

- Regulación de varias alturas intermedias de la persiana.
- Función de actualización automática dinámica de los finales de carrera que compensa el alargamiento o encogimiento de la estructura y permite la máxima precisión de las posiciones de la persiana.

Motor with electronic limit switch and built-in receiver for automating roller shutters and awnings.

We have a wide range of motors that provide functional versatility for your roller shutter and awning systems:

- Several intermediate shutter heights can be set.
- Automatic dynamic limit switch update function that compensates for the elongation or shrinkage of the structure and allows maximum precision of the shutter positions.

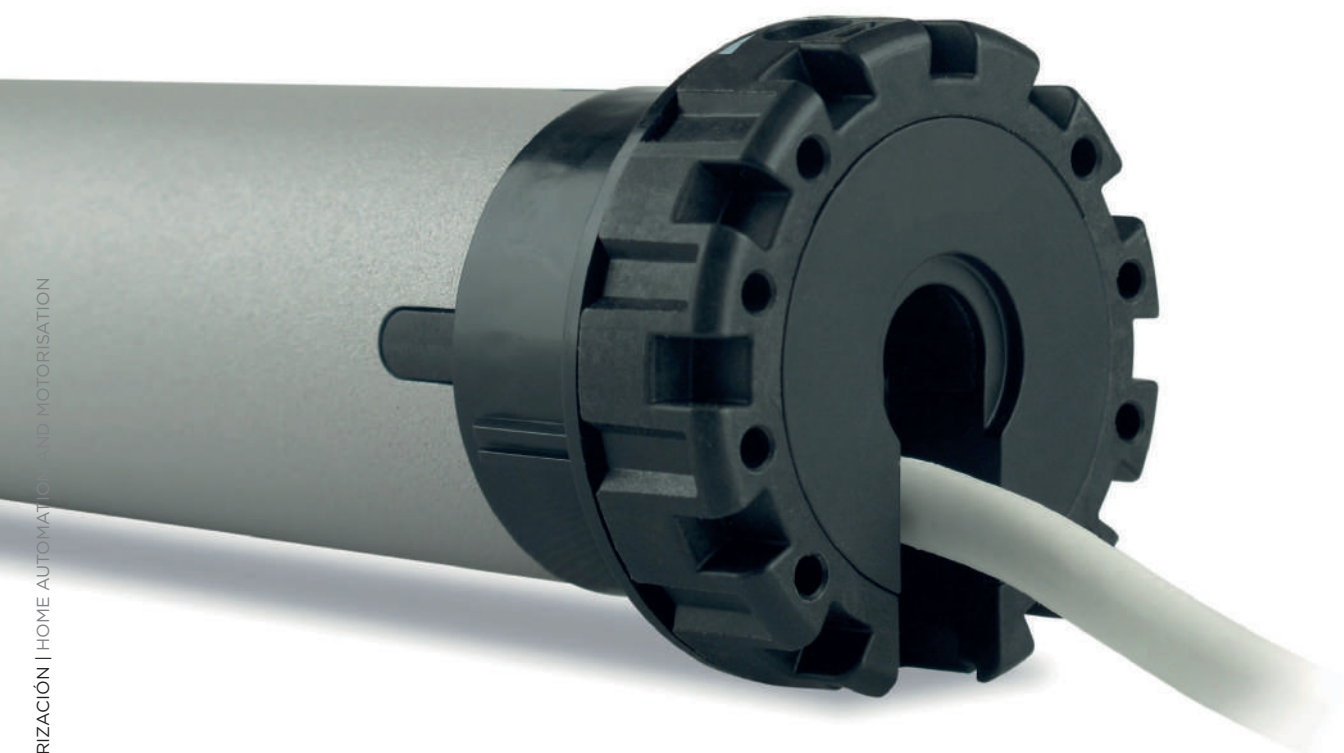

DOMÓTICA

HOME AUTOMATION

Toma el control del confort de tu vivienda. Todo a golpe de clic.

Con los nuevos sistemas de motorización que propone STRUGAL podrás controlar los distintos sistemas de protección solar de tu vivienda desde tu móvil a través de una app específica o desde el mando a distancia bidireccional.

Conectamos todos los automatismos de tu casa, comunicándose entre sí y contigo mediante la red Mesh.

Take control of the comfort of your home. All at the click of a button.

With the new motorisation systems offered by STRUGAL, you will be able to control the different sun protection systems in your home from your mobile phone via a specific app, or from the bi-directional remote control.

We connect all the automation systems in your home, so they communicate with each other and with you via the Mesh network.

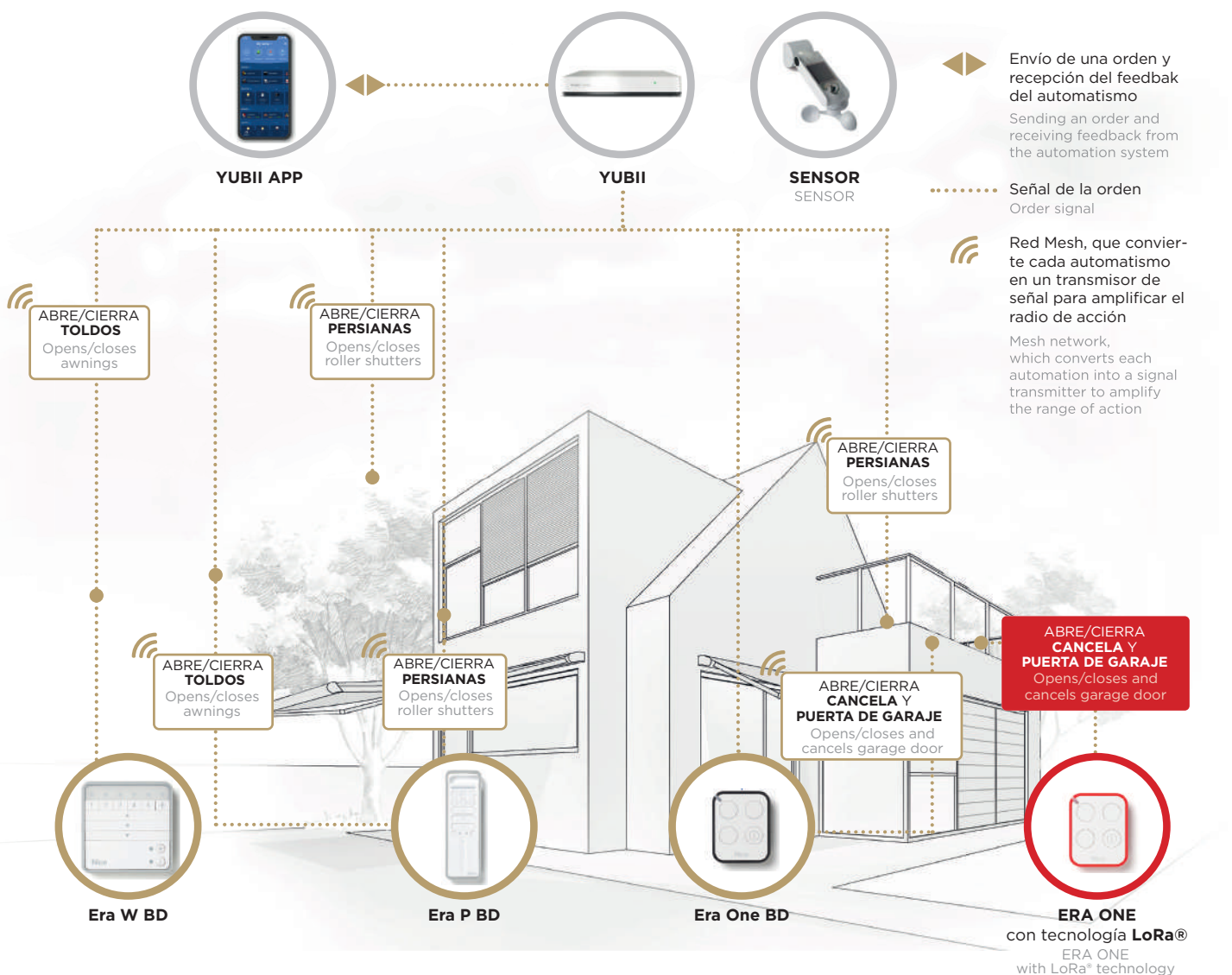

ACCIONAMIENTOS Y MOTORES

ACTUATORS AND MOTORS

| MANIVELAS Handles |
|---------------------------------------|
| MFCP120 - Manivela de handle 1.200 mm |
| MFCP140 - Manivela de handle 1.400 mm |
| MFCP160 - Manivela de handle 1.600 mm |
| MFCP180 - Manivela de handle 1.800 mm |
| MFCP200 - Manivela de handle 2.000 mm |
| MFCP240 - Manivela de handle 2.400 mm |

■ NICE

| MOTOR MECÁNICO Mechanical motor |
|---|
| M35: ERA S 13/11 |
| M45: TG M 18/17 |
| M45: TG M 30/17 |
| M45: TG M 40/12 |
| M45: TG M 50/12 |
| MOTOR ELECTRÓNICO Electronic motor |
| M35: ERA MAT ST 10/11 |
| M45: ERA FIT M 15/17 |
| M45: ERA FIT M 30/17 |
| M45: ERA FIT M 40/12 |
| M45: ERA FIT M 50/12 |
| M55: ERA MAT LT 75/17 |
| EMISORES Emitters |
| MINI WAY 1 |
| ERA MINI WAY 3 |
| ERA P6S |
| ERA PIS |
| AUTOMATISMOS Automation |
| NEMO WSCT |

■ CHERUBINI

| |
|--|
| MOTOR MECÁNICO Mechanical motor |
| SERIE ROLL Ø45 |
| MOTOR ROLL 10/17 |
| MOTOR ROLL 20/17 |
| MOTOR ROLL 30/17 |
| MOTOR ROLL 40/17 |
| MOTOR ROLL 50/12 |
| MOTOR ELECTRÓNICO Electronic motor |
| SERIE ORA ZRX Ø45 |
| MOTOR ORA ZRX 15/17 |
| MOTOR ORA ZRX 25/17 |
| MOTOR ORA ZRX 32/17 |
| MOTOR ORA ZRX 40/17 |
| MOTOR ORA ZRX 50/12 |
| EMISORES AVV STD Emitters |
| POP MONOCANAL |
| POP PLUS (multicanal Multigroove) |
| EMISORES TDS Emitters |
| EMISOR POP LUX (sol/viento sun/wind) |
| EMISOR POP P-LUX (multicanal sol/viento multigroove sun/wind) |
| AUTOMATISMOS TDS Automation |
| CENTRAL WINDTEC (viento wind) |
| CENTRAL WINDTEC LUX (sol/viento sun/wind) |
| MISTRAL (vibración vibration) |

■ AOK

| |
|---|
| MOTOR MECÁNICO Mechanical motor |
| MOTOR 45 mm.f.c.m.P/INVERSOR AM45 BASIC 15/17 Nm. (AM45-15/17) |
| MOTOR 45 mm.f.c.m.P/INVERSOR AM45 BASIC 30/17 Nm. (AM45-30/17) |
| MOTOR 45 mm.f.c.m.P/INVERSOR AM45 BASIC 50/12 Nm. (AM45-50/12) |
| MOTOR ELECTRÓNICO Electronic motor |
| MOTOR 45 mm.f.c.e.VIA RADIO 15/17 Nm. FSK BIDI (AM45-15/17 FSK 2) |
| MOTOR 45 mm.f.c.e.VIA RADIO 30/17 Nm. FSK BIDI (AM45-30/17 FSK 2) |
| MOTOR 45 mm.f.c.e.VIA RADIO 50/12 Nm. FSK BIDI (AM45-50/12 FSK 2) |
| EMISORES Emitters |
| EMISOR APOLO 1 CANAL (AC136-02 SUN) |
| EMISOR APOLO 5 CANALES (AC136-05 SUN) |
| EMISOR APOLO 1 CANAL (AC136-02 SUN) |
| EMISOR APOLO 5 CANALES (AC136-05 SUN) |
| AUTOMATISMOS Automation |
| SENSOR VELETA VIENTO SOL VIA RADIO CABLEADO (AC-302-02) BIDI |
| SENSOR VIENTO 3D BARRA DE CARGA (AC115-01) BLANCO |



NUESTRO COMPR



ROMISO

OUR **PLEDGE**



LA DIFERENCIA ES LA CALIDAD

THE DIFFERENCE IS IN THE QUALITY

En STRUGAL ofrecemos un **servicio 360º**: ejecutamos desde el diseño hasta la fabricación completa del producto con la **tecnología más avanzada del mercado**.

Nuestros productos se someten a procesos exhaustivos de control de calidad. De esta forma cuentan con el respaldo de un producto terminado por el fabricante.

At STRUGAL, we offer a **360º service**: from the design to the complete manufacture of the product with the **most advanced technology on the market**.

Our products undergo exhaustive quality control processes. This way, they have the backing of a product finished by the manufacturer.

Para STRUGAL, la calidad es la base y a la vez el objetivo final. Trabajamos para ofrecerte un producto a la altura de tus expectativas, y esto se nota a muchos niveles:

1. PROCESO DE FABRICACIÓN CONTROLADO

al 100% en nuestras instalaciones.

2. DESARROLLO DE SISTEMAS EXCLUSIVOS,

concebidos por nuestro departamento de I+D+i con la tecnología más avanzada.

3. GARANTÍA ABSOLUTA CON EL RESPALDO DEL FABRICANTE.

4. NUEVAS OPORTUNIDADES DE NEGOCIO

PARA NUESTROS CLIENTES, ofreciéndoles una mayor gama de productos y ampliando sus posibilidades.

For STRUGAL, quality is both the basis and the ultimate goal. We work to offer you a product that lives up to your expectations, and this shows on many levels:

1. 100% CONTROLLED MANUFACTURING PROCESS in our facilities.

2. DEVELOPMENT OF EXCLUSIVE SYSTEMS, ideated by our R+D+i department with the most advanced technology.

3. ABSOLUTE GUARANTEE WITH THE MANUFACTURER'S BACKING.

4. NEW BUSINESS OPPORTUNITIES FOR OUR CUSTOMERS, offering them a wider range of products and expanding their options.



SOSTENIBILIDAD

SUSTAINABILITY

En STRUGAL aplicamos una estricta política medioambiental, en línea con la responsabilidad social de la empresa. Por ello, **reciclamos y trabajamos con materiales sostenibles.**

Certificamos nuestra excelencia en política medioambiental mediante una **DAP (Declaración Ambiental de Producto)** certificada por AENOR.

Gracias a esta certificación ofrecemos a nuestros clientes un perfil ambiental fiable, relevante, transparente, comparable y verificable, que comunica el respeto medioambiental de la empresa.

Prácticamente la totalidad de los productos de aluminio pueden, desde un punto de vista técnico (factibilidad) y económico (rentabilidad), ser reciclados repetidamente, para producir nuevos productos, sin perder el metal su calidad y propiedades. La utilización de metales reciclados ahorra energía y preserva las fuentes de recursos naturales. Es por eso que el creciente uso del aluminio reciclado en diversas aplicaciones le da el reconocimiento de metal verde.

Nuestros centros de producción están dotados de estaciones depuradoras que minimizan el impacto de aguas residuales en los procesos de lacado y anodizado.

El ahorro energético y el uso de materiales sostenibles son un claro objetivo dentro de nuestra compañía. Por ello, colaboramos con los estudios de arquitectura, asesorándoles en sus proyectos y asegurando el cumplimiento, en todo momento, del Código Técnico de Edificación. El uso adecuado de las Series STRUGAL con Rotura de Puente Térmico contribuyen al ahorro energético en las edificaciones que llevamos a cabo.

At STRUGAL, we apply a strict environmental policy, in line with the company's social responsibility policy. Therefore, **we recycle and work with sustainable materials.**

We certify our environmental policy excellence through an **EPD (Environmental Product Declaration)** certified by AENOR.

This certification allows us to offer our clients a reliable, relevant, transparent, comparable and verifiable environmental profile, which communicates the company's respect for the environment.

Practically all aluminium products can, from a technical (feasibility) and economic (profitability) point of view, be repeatedly recycled to produce new products, without the metal losing its quality and properties. Using recycled metals saves energy and preserves natural resources. For this reason, the increasing use of recycled aluminium in various applications means it is recognised as a green metal.

Our production centres are equipped with purification stations that minimise the impact of waste water in the lacquering and anodising processes.

Energy saving and the use of sustainable materials are a clear objective within our company. To further this, we collaborate with architecture firms, advising them on their projects and ensuring compliance, at all times, with the Technical Building Code. The proper use of the STRUGAL Thermal Bridge Rupture Series contributes to energy savings in the buildings that we work on.

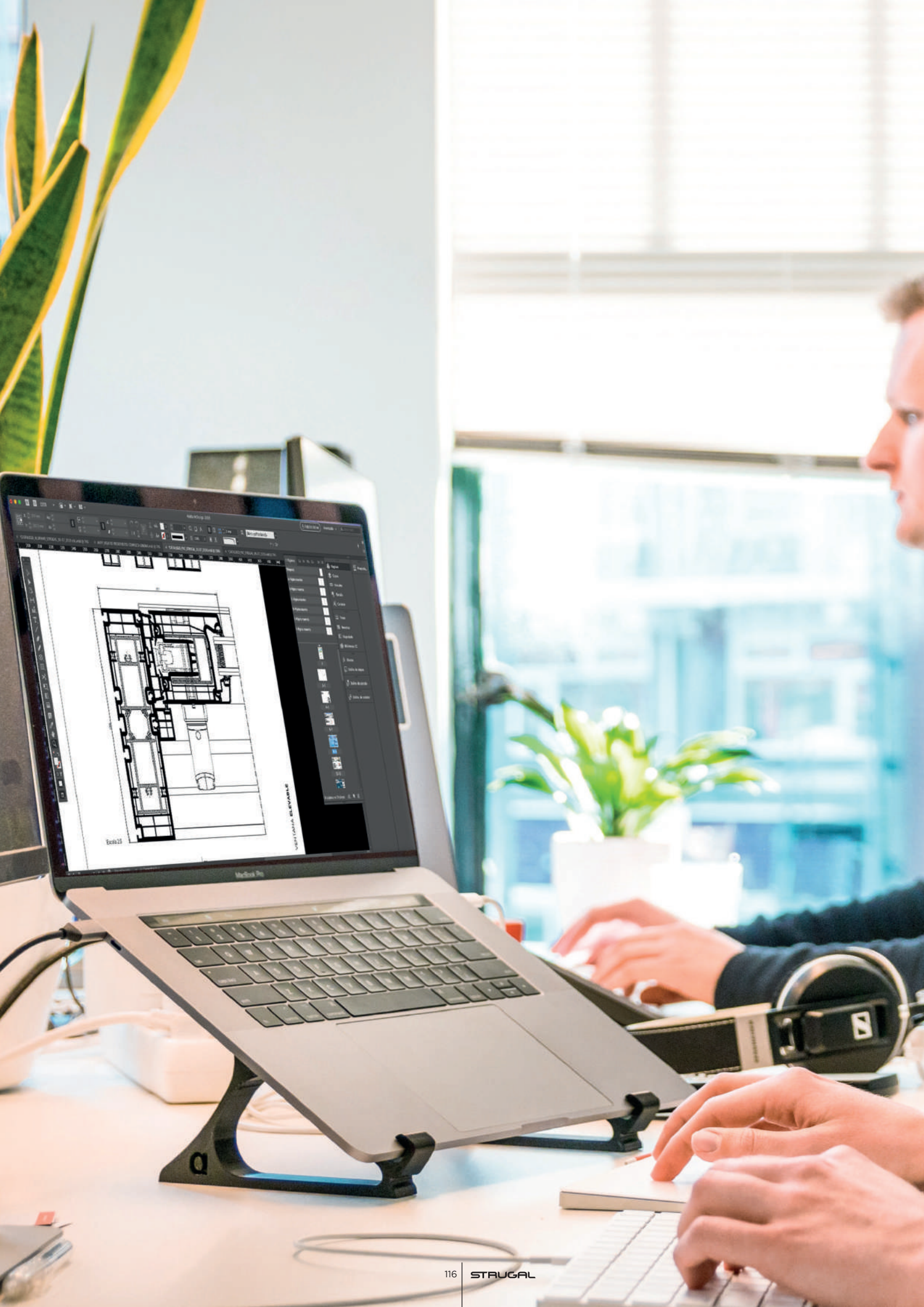

AL SERVICIO DEL INSTALADOR

AT THE **INSTALLER'S SERVICE**



ASISTENCIA TÉCNICA

STRUGAL cuenta con un **Servicio de Asistencia Técnica pionero en el sector de la Protección Solar** para la atención individualizada de las consultas técnicas y normativas de instaladores, arquitectos y promotores.

- Resolución de detalles y encuentros en obra.
- Cálculo de estructuras de sistemas de Protección Solar.
- Asesoramiento CTE.
- Marcado CE.

SOFTWARE PRESUPUESTACIÓN

STRUGAL pone a su disposición dos programas de presupuestación y gestión de pedidos de fácil manejo que le facilitará todas sus operaciones diarias. Consulte qué opción se adapta mejor a sus necesidades.

- Actualizado en tiempo real.
- Posibilidad de introducir su logotipo en los presupuestos.
- Consulta del estado de sus pedidos online.
- Modificación y ajuste de márgenes.

MARCADO CE

El **MARCADO CE** es un pasaporte técnico para el producto en Europa. Significa que el producto cumple con las normas impuestas en las Directivas Europeas para ser comercializado en cualquier país perteneciente a la (UE) Nº 305/2011.

Esta certificación es de carácter obligatorio desde febrero de 2010 para la comercialización de ventanas y puertas peatonales exteriores.

Respondemos a la normativa con el Marcado CE en todos nuestros productos.

TECHNICAL SUPPORT

STRUGAL has a **pioneering Technical Assistance Service in the Sun Protection sector** for individualised attention on the technical and regulatory queries of installers, architects and developers.

- Resolution of details and on-site meetings.
- Calculation of Sun Protection system structures.
- CTE advice.
- CE marking.

SOFTWARE BUDGETING

STRUGAL has two easy-to-use budgeting and order management programmes at your disposal to facilitate all your daily operations. See which option best suits your needs.

- Real-time updates.
- Option of placing your logo on quotes.
- Checking the status of your online orders.
- Modification and adjustment of margins.

CE MARKING

CE MARKING is a technical passport for the product in Europe. It means that the product complies with the standards imposed in the European Directives for commercialisation in any EU country (EU) No. 305/2011.

This certification has been mandatory since February 2010 for the sale of windows and exterior pedestrian doors.

We comply with the regulations with CE Marking on all our products.



STRAUGAL

SOLVENCIA EN PRODUCCIÓN

EFFICIENCY IN PRODUCTION

Los centros de corte y mecanizado más modernos y automatizados de España nos permiten responder con **total solvencia e inmediatez a las más exigentes demandas de producción.**

En la actualidad contamos con una capacidad de producción de 180.000 unidades de toldos al año, y 150.000 unidades de persianas al año, lo que nos posiciona como **la empresa líder del sector en España.**

Nuestras líneas de producción están totalmente informatizadas a través de nuestro software de producción que nos permite tener un conocimiento a tiempo real de las cargas y flujos de las diferentes líneas.

Esto nos lleva a tener un estricto control sobre el proceso productivo optimizando los tiempos y costes de fabricación.

Todo el proceso productivo está diseñado y ejecutado en función de las normativas vigentes con los controles de calidad y ensayos más exigentes que **garantizan un producto final de máxima calidad.**

The most modern and automated cutting and machining centres in Spain allow us to respond with the **utmost efficiency and immediacy to the most demanding production needs.**

We currently have a production capacity of 180,000 awning units per year and 150,000 blinds units per year, which makes us **the leading company in the sector in Spain.**

Our production lines are fully computerised through our production software, which provides us with real-time knowledge of the loads and flows of the different lines.

This gives us strict control over the production process, optimising manufacturing times and costs.

The entire production process is designed and executed in accordance with current regulations, with the most demanding quality controls and tests that **guarantee a final product of the highest quality.**



SISTEMA DE **DISTRIBUCIÓN**

DISTRIBUTION SYSTEM

STRUGAL dispone de un Sistema Integral de Distribución con flota de camiones propia que conecta "puerta a puerta" el Centro Productivo con el instalador semanalmente en cualquier punto de la península gracias a su ubicación estratégica.

Porque el tiempo es importante, porque nuestros clientes no pueden esperar, porque necesitamos la máxima eficacia en distribución.

STRUGAL, logística de futuro.

STRUGAL has a Comprehensive Distribution System with its own fleet of trucks that provides a "door to door" connection between the Production Centre and the installer on a weekly basis, and at any location on the peninsula thanks to its strategic location.

Because time is important, because our customers cannot wait, because we need maximum distribution efficiency.

STRUGAL, logistics of the future.





Todos los datos incluidos en este catálogo son únicamente a título informativo, por tanto, la empresa no se hace responsable de posibles errores de impresión u otros de carácter técnico y tipográfico.

STRUGAL se reserva el derecho de modificación de la información aportada. Queda prohibida la reproducción total y parcial de este documento, salvo autorización expresa de STRUGAL.

Los sistemas de ventanas y puertas en contacto directo con el sol pueden sufrir alteraciones a partir de los 50°C o sometidos a cambios bruscos de temperatura.

Todos los sistemas incluidos en este catálogo están patentados y son propiedad exclusiva de STRUGAL, estando protegidos por Ley. STRUGAL no se responsabilizará del uso incorrecto de sus sistemas.

All data included in this catalogue is for informational purposes only. The company is therefore not responsible for possible printing errors or other technical and typographical errors.

STRUGAL reserves the right to modify the information provided. Total or partial reproduction of this document is prohibited, unless expressly authorised by STRUGAL.

Window and door systems in direct contact with the sun can be affected at temperatures above 50°C or when exposed to sudden changes in temperature.

All the systems included in this catalogue are patented and are the exclusive property of STRUGAL, and protected by law. STRUGAL will not be held responsible for the incorrect use of its systems.

STRUGAL

Europa

Europe

Alemania - Austria - España
Francia - Inglaterra - Italia
Polonia - Portugal

América

America

Antillas Neerlandesas - Chile - Colombia
Costa Rica - Ecuador - Perú - Estados
Unidos - Guayana francesa - México - Panamá
República Dominicana - Uruguay

África

Africa

Argelia - Guinea Ecuatorial
Marruecos - República de
Cabo Verde





ST

www.strugal.com

f @ p in